



Technical Service Bulletin

SUBJECT:			No: TSB-16-22-003
TC-SST TRANSMISSION & MECHATRONIC ASSEMBLY DIAGNOSIS & REPAIR – REVISED			DATE: July, 2016
			MODEL: See below
CIRCULATE TO:	<input type="checkbox"/> GENERAL MANAGER	<input checked="" type="checkbox"/> PARTS MANAGER	<input checked="" type="checkbox"/> TECHNICIAN
<input checked="" type="checkbox"/> SERVICE ADVISOR	<input checked="" type="checkbox"/> SERVICE MANAGER	<input checked="" type="checkbox"/> WARRANTY PROCESSOR	<input type="checkbox"/> SALES MANAGER

This bulletin supercedes TSB-15-22-002, issued July, 2015, to revise specific steps for selecting reprogramming data in the “Program New Transmission Control Module (TCM)” and “Reprogram 2008 Lancer Evolution TCM with Correct Software” sections. Revisions are italicized and indicated by ◀.

PURPOSE

Procedures are now available for W6DGA TC–SST Mechatronic Assembly (valve body and transmission control module) replacement. This TSB provides the necessary steps to complete diagnosis, replace the Mechatronic Assembly, and program the new electronic control unit.

Until now, authorized repairs for the TC–SST were limited to replacement of axle seals, transmission oil pan and gasket, and the external oil filter. With the addition of Mechatronic Assembly replacement, transmission replacement is no longer required to address the most common TC–SST symptoms.

This TSB covers the following subjects:

1. An overview of the TC–SST operation (page 2).
2. Diagrams of the transmission showing selected replacement parts (page 4).
3. A Customer Interview Worksheet to be used by dealer service personnel to identify specific transmission concerns (page 6).
!! IMPORTANT !! You are required to submit a completed Customer Interview Worksheet to Techline for parts release.
4. Transmission troubleshooting instructions (page 7).
5. Mechatronic assembly replacement instructions including TCM programming (page 14).
6. A Quality Control Checklist to verify proper repair (page 41).
7. Part number information (page 42).

Diagnosis and repairs for DTCs and other symptoms not covered by this TSB may require transmission replacement. For TC–SST diagnosis and repairs not covered by this TSB, contact Techline for assistance.

NOTE: Unlike most Mitsubishi electronic control units, a new Mechatronic assembly’s TCM is not programmed with operating software. When a new Mechatronic assembly is installed, the technician must program it following the steps provided in this TSB.

Repairs to the TC–SST are limited to the following:

- Mechatronic assembly replacement and programming
- Teach–in procedure for all model years (2008 Lancer Evolution is unique)
- External oil filter/housing replacement
- Axle seal replacement
- Oil pan and pan seal replacement

AFFECTED VEHICLES

2008 – 2015 Lancer Evolution with TC–SST

2009 – 2015 Lancer Ralliart Edition with TC–SST

2009 – 2011 Lancer Sportback Ralliart Edition with TC–SST

TC-SST OPERATION OVERVIEW

The Mitsubishi TC-SST is an automated, 6-speed manual transmission. It contains the mechanical gearing, hydraulic control (valve body) and the transmission control module (TCM). The valve body and TCM are known as the Mechatronic Assembly. They are permanently attached to each other and cannot be replaced separately.

The TC-SST distributes power in a manner similar to any other manual transmission. It uses gears with brass synchronizers controlled by shift rails and forks to transmit power to the drive wheels. However, the TC-SST uses two gear shafts; one for odd numbered gears and one for even numbered gears. The automated portion of the transmission incorporates hydraulic servos to move the shift forks that engage the gears, magnetic sensors to inform the TCM of shift fork positioning, other sensors to monitor clutch pack speed, a valve body to direct hydraulic oil flow to appropriate points, and wet clutches (one per shaft) to engage or disengage the odd or even gear shaft at the correct time.

The wet clutch system performs a similar function to a torque converter in an automatic transmission. The clutches are fully disengaged to allow the vehicle to idle, or engaged one at a time, allowing engine torque to be transmitted through the gears on either the odd or even gear shaft.

The advantages of using the twin clutch setup are:

- increased shift speed
- reduced torque loss during shifts
- improved fuel economy

Shift Pattern

The driver can select either “Automatic Mode” or “Manual Mode” using the shift lever.

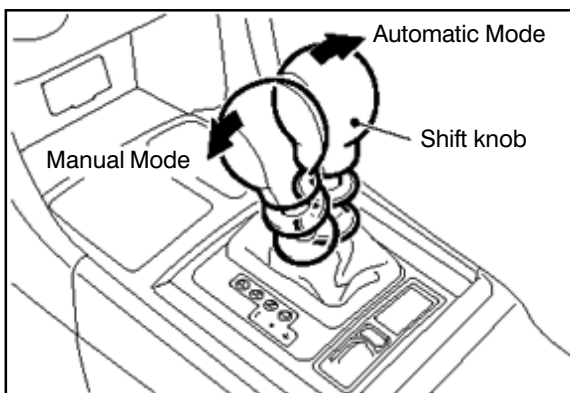

In automatic mode, the transmission shifts gears based on shift mapping programmed into the transmission control module, similar to a conventional automatic transmission. In the manual mode, sequential gear shifting is performed using either the floor shifter (+ for upshifts, — for downshifts), or the steering column mounted paddle shifters (right hand for upshifts, left hand for downshifts).

Shift Lever Position	Paddle Shift Operated	Shift Mode
D Range	No	Automatic mode
	Yes	Shifting gears switches to manual mode. NOTE: Returns to automatic mode when vehicle speed drops to 6.25 mph (10 km/h). If the right hand shift paddle is pulled and held for more than 2 seconds, manual mode is cancelled.
Manual Shift Gate (+/—)	No/Yes	Manual mode NOTE: In manual mode, as the vehicle slows, the TCM automatically commands downshifts to select a gear appropriate to vehicle speed.

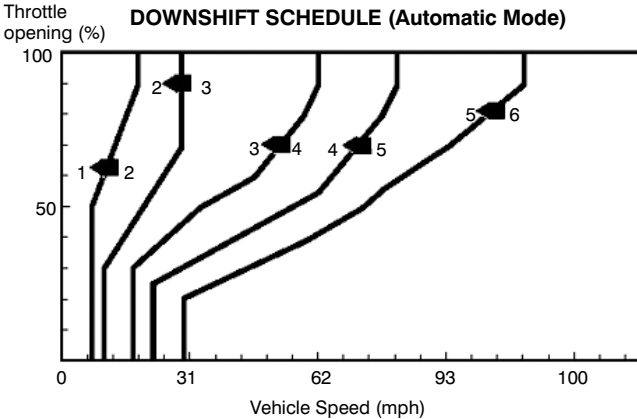
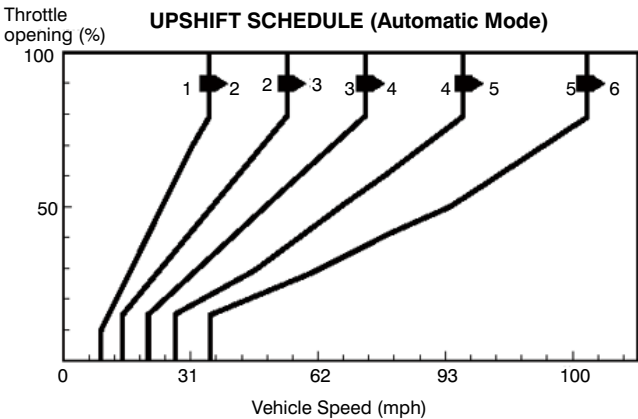

Drive Mode

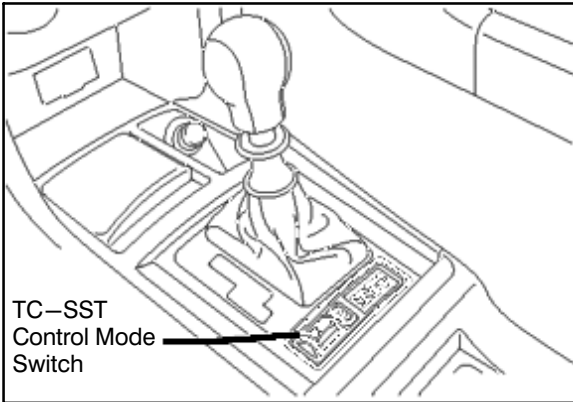

Ralliart models have two drive modes: Normal and Sport.

Lancer Evolution models have three drive modes: Normal, Sport and Super Sport.

When the engine is started, the drive mode defaults to Normal.

Each drive mode has a specific shift “feel.” The softest shift feel occurs in the default Normal mode. In Sport mode, shifts are quicker and occur at higher RPM. In Super Sport mode, shifting is the most aggressive. Shifts occur at even higher engine speeds and even more quickly than Sport mode. (Super Sport is not recommended for normal street use as shifting is very harsh).

Drive Mode	Shift Pattern (Affects only Auto mode)	Clutch Response	Accelerator Response
Normal (Default)	Low Engine Speed Range	Smooth	Smooth
Sport	Middle Engine Speed Range (2,500–4,000 RPM)	Quick	Quick
Super Sport	High Engine Speed Range (4,500–7,000 RPM)	Very Quick	Very Quick

Creep Function

The TCM is programmed to slip the clutches in both D and R ranges (a semi-engaged state) to enable a creep drive condition similar to that provided by an automatic transmission torque convertor.

Kick Down Function

A kick down function (similar to an automatic transmission) is programmed into the TCM and allows automatic downshifts when the accelerator pedal is fully depressed, providing quicker acceleration.

Fast Off Function

Under normal circumstances, with the transmission in D range, when the accelerator pedal is suddenly released, the transmission upshifts to better suit vehicle speed. However, under certain parameters, a “fast off” function prevents upshifts in order to achieve engine braking.

Network Communication

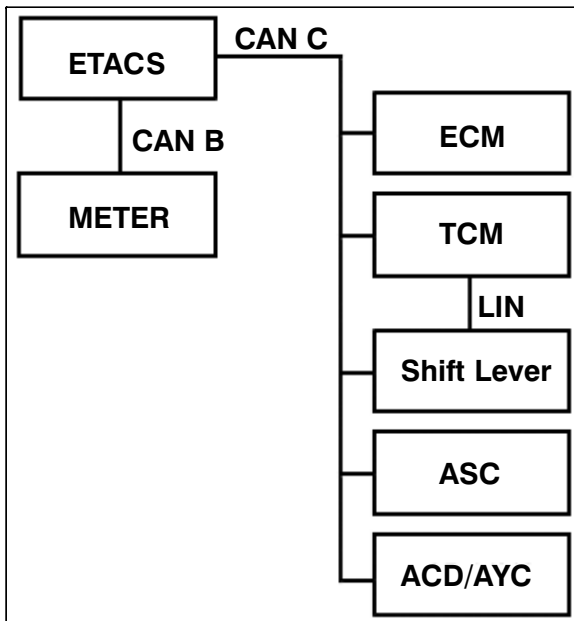

The TC-SST, like most of the vehicle’s major components, is constantly communicating with other control units linked via the CAN C bus line. When diagnosing electrical issues, it is important to focus on proper electrical connections and communication. It also means that, similar to the vehicle’s other control units, MUT-III must be used to program the TCM after replacement. Part of this TSB will focus on procedures for proper coding when replacing Mechatronic assemblies.

Current Replacement Parts

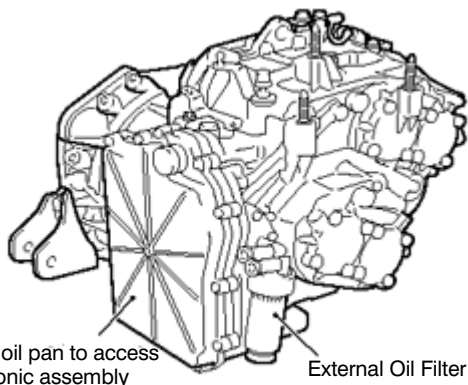

The TC-SST transmission has two filter elements. Only the external oil filter element and the Mechatronic Assembly can be replaced at this time.

The combined Mechatronic Valve Body and TCM are accessible under the oil pan.

DIAGNOSIS AND REPAIR OVERVIEW

Following is an overview of the diagnostic steps contained in this TSB. Specific procedures to be followed in sequence begin on page 7. Do not perform diagnosis or repairs using this overview alone.

1. The Customer Interview Worksheet will help determine the specific transmission concerns.

!! IMPORTANT !! You are required to submit the worksheet to Techline for parts release. An electronic copy can be downloaded from the “service tech resources” page of the MDL.

2. Perform a thorough visual inspection and check the basics.
 - Note any transmission related MID display messages.
 - Check transmission fluid level and condition. Refer to the service manual for the proper procedure.
 - Check Battery voltage (> 12.4V as measured at the battery).
 - Verify no electrical or performance accessories are installed.
 - Verify integrity of transmission electrical harness and associated connectors.
3. Connect MUT-III to the vehicle.

NOTE: If engine ECU or TCM tampering is suspected, contact your DPSM and Techline with the details.

- Perform CAN bus check.
 - Record DTCs and Freeze Frame Data. Then perform Erase and Read DTCs.
4. Road test the vehicle to verify the concern and duplicate any previously retrieved DTCs.
 5. If DTCs listed on page 8 are present after the road test, perform Transmission Control Module (TCM) “Copy Coding” to MUT-III in preparation of replacing the Mechatronic assembly.

!! IMPORTANT !! DO NOT remove the transmission prior to performing copy coding.

NOTE: Using Copy Coding is highly recommended. If Copy Coding is not used, Download Coding, which requires additional programming for any installed accessories, must be completed.

If Download Coding is necessary, use the correct TCM part number from the following table.

VEHICLE	TRANSMISSION PART NO.	TCM SOFTWARE PART NO.
2009 Lancer Ralliart	2500A124 2500A306	8631A8600B ↓
2010 Lancer/Lancer Sportback Ralliart	2500A124 2500A306	
2011-15 Lancer/Lancer Sportback Ralliart	2500A344	8631A972
2008 Lancer Evolution	2500A137	8631A3790E
2009 Lancer Evolution	2500A277	8631A8270B ↓
2010 Lancer Evolution	2500A305	
2011-15 Lancer Evolution	2500A343	8631A971

6. Replace the Mechatronic assembly.
7. Program the Transmission Control Module (TCM).
8. Perform VIN Writing for new Transmission Control Module (TCM).
9. Perform “On Vehicle Coding” from MUT-III to TCM using data copied in step 5 above.
10. Perform “Teach-In” procedure.
11. Road test the vehicle to verify repair.
12. Complete Quality Control Checklist.

CUSTOMER INTERVIEW WORKSHEET FOR TC-SST TRANSMISSION

Submitting a completed Customer Interview Worksheet to Techline is required for parts release.

Fax the completed worksheet to 714.934.4279 (in Canada: 905.214.9089).

VIN _____ Dealer Code _____ Techline Case # _____

- Have any aftermarket devices been installed on this vehicle? Yes or No (circle one)
(e.g.: engine or transmission modifications, navigation units, gauges, tracking devices, etc.)
- Approximate Date/Time symptom occurred: _____
- Continuous or Intermittent concern (circle one) # of times per day, or week, or month _____
- Weather (circle one): Wet or Dry Ambient Temperature: Hot or Cold (circle one)
- Road conditions (circle selections): Wet or Dry Ice or Snow Off road or Gravel
- Engine RPM (approx.) _____ Engine Temperature : Hot or Cold (circle one)
- Vehicle MPH (approx.) _____ Steady Cruise/Acceleration/Deceleration (circle one)
- Drive Mode: Normal Sport Super-Sport (circle one)
- MID warning indicators: _____ When concern occurs or always? _____
- Is the R indicator on MID flashing? Yes or No (circle one)
- Engine starts and runs normally? Yes or No (circle one) If No, describe in "Other Comments" below.
- Vehicle accelerates normally? Yes or No (circle one)
If no, circle mode: Normal Sport Super-Sport
- Harsh shifts while driving? ____ If yes, which mode (circle one): Normal Sport Super-Sport
- Does transmission upshift properly (1st – 2nd – 3rd – 4th – 5th – 6th)? Yes or No (circle one)
If no, improper upshifts occur from which gear(s) _____ to which gear(s) _____
- Does the transmission downshift properly (6th – 5th – 4th – 3rd – 2nd – 1st)? Yes or No (circle one)
If no, improper downshifts occur from which gear(s) _____ to which gear(s) _____
- Are shift points affected? ____ Any gear shift noise? ____ Noises in park/neutral? ____
- Any transmission fluid leakage? ____ If yes, where _____ What amount _____
- Other Comments

List Diagnostic Trouble Codes (including MFI) below and circle Active or Stored for each entry. Also include the service group for the system where each DTC is found. Techline personnel require this information if a case is opened.

Svc. Grp	DTC	STATUS	Svc. Grp	DTC	STATUS	Svc. Grp	DTC	STATUS
		Active or Stored			Active or Stored			Active or Stored
		Active or Stored			Active or Stored			Active or Stored
		Active or Stored			Active or Stored			Active or Stored
		Active or Stored			Active or Stored			Active or Stored

Perform the ACTION TO TAKE after each DIAGNOSTIC STEP listed below:

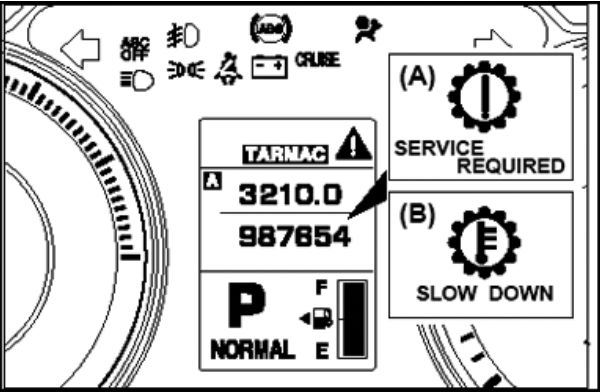
DIAGNOSTIC STEP	ACTION TO TAKE
<p>DIAG 1) Are there any transmission related MID messages displayed? (Yes or No)</p>	<p>Note any messages and continue diagnosis at DIAG 2.</p>
	<p>A. If the Service Required message is displayed, check for DTCs.</p> <p>B. If the Slow Down message is displayed, the transmission is overheating. Ask the customer if they have noticed this message displayed.</p> <p>The SLOW DOWN message displays if transmission temperature exceeds 250°F. If the transmission temperature exceeds 260°F, the ECU and TCM will take steps to cool down the transmission including reducing power and disengaging the clutches.</p>
<p>DIAG 2) Is there any aftermarket equipment (engine or transmission performance equipment, navigation units, gauges, tracking devices, etc.) installed on this vehicle? (Yes or No)</p> <p>Pay special attention to those devices which can be linked to the vehicle communications networks (CAN B, CAN C, or LIN).</p>	<p>If aftermarket equipment is found, disconnect it or render it inoperative for the remainder of this diagnosis. Go to DIAG 3.</p>
<p>DIAG 3) Are there any transmission fluid leaks? (Yes or No)</p>	<p>Note the location(s) of any leaks and continue diagnosis at DIAG 4.</p>
<p>DIAG 4) Is the valve body electrical harness connector fully seated? (Yes or No)</p>	<p>If no, secure the connector. After preparing the scan tool as shown on pages 9–11, continue to DIAG 5.</p>
<p>DIAG 5) Perform CAN Bus Diagnosis to confirm proper network communication. If necessary, consult GROUP 54C of the Service Manual for the procedure.</p>	<p>Follow Service Manual procedures (GROUP 54C) for any ECUs failing CAN Bus diagnosis. After diagnosis and repair of CAN Bus, continue diagnosis at Step DIAG 6.</p> <p>If CAN Bus diagnosis passed, continue diagnosis at Step DIAG 6.</p>

DIAGNOSTIC STEP	ACTION TO TAKE
DIAG 6) Read all DTCs. Note any transmission related DTCs for future reference. Confirm no DTCs are stored in the TCM before beginning DIAG7.	Record Freeze Frame Data for <u>ALL</u> DTCs. Repair DTCs in other systems. Conduct Erase and Read All DTCs. Repair as necessary. Continue diagnosis at step DIAG 7.
DIAG 7) Thoroughly road test the vehicle. Attempt to duplicate any concerns identified from the Customer Interview Worksheet.	Continue diagnosis at step DIAG 8.
DIAG 8) Recheck for DTCs stored in the TCM. Compare received DTCs with the list below.	If DTCs <u>listed below left are recorded in TCM memory</u> , perform TCM “Copy Coding” to MUT-III on page 12.

P0630 P0701 P0702 P0712 P0713 P0715 P0716 P0717 P0725 P0746 P0753 P0758 P0776 P0842 P0843 P0847 P0848 P0960 P0961 P0962 P0963 P0964	P0965 P0966 P0967 P0968 P0970 P0971 P0973 P0974 P0976 P0977 P1637 P1676 P1802 P1804 P1805 P1806 P1807 P1808 P180C P181C P181F P1852	P1855 P1862 P1863 P1864 P1866 P1867 P1868 P186A P186B P186C P186D P186E P186F P1870 P1871 P1872 P1880 P1881 P2718 P2719 P2720 P2721	P2727 P2728 P2729 P2730 P2733 P2736 P2738 P2739 P2742 P2743 P2809 P2812 P2814 P2815 U0001 U0100 U0103 U0121 U0136 U0141	If DTCs are stored in the TCM, but not listed in the columns at left, perform the following steps: <ul style="list-style-type: none"> ● Contact your DPSM for transmission replacement authorization. ● Fax a completed Customer Interview Worksheet to Techline. ● Perform “Copy Coding” to MUT-III ● Replace the transmission assembly. ● Perform VIN write. ● Perform “Copy Coding” to TCM. ● Road test to confirm repair with Quality Control Checklist at the end of this TSB (page 40).
--	--	--	--	--

SCAN TOOL SETUP

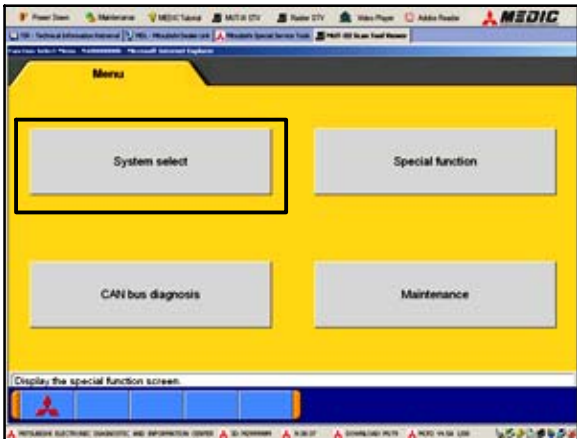

1. Connect MUT-III to the vehicle and turn the ignition switch to ON (RUN).
2. At the MUT-III main menu, choose **System Select**.

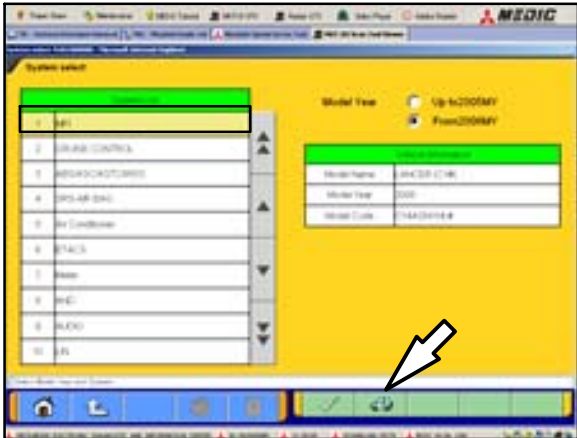

3. Select "From 2006 MY."
4. Click the car icon at the bottom of the screen.



5. Click the eraser icon at the bottom of the screen to erase all vehicle data.

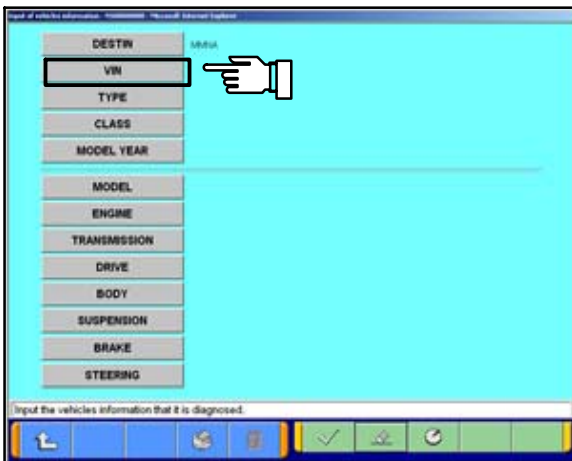

6. Click the VIN button.



7. Click on the icon in the lower RH corner of the screen to have MUT-III automatically read the VIN. If a message appears advising the VIN cannot be input automatically, enter the 17 digit VIN.

Confirm VIN is correct and click the **check mark** to continue.

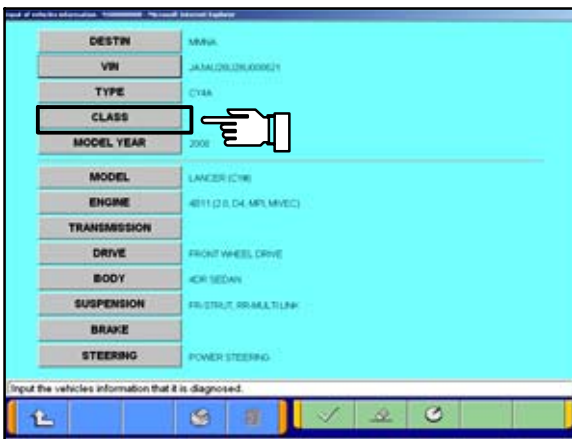

8. If the vehicle class is not complete, click the CLASS button.

NOTE: in some cases, selecting the proper transmission (arrow) automatically fills in the proper "CLASS."

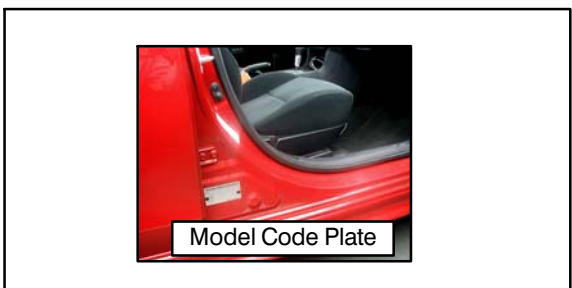

9. Vehicle class can be found on the model plate attached to the right side B-pillar.



10. Make the selection for the class found on the Model Code Plate.

Click on the **check mark** at the bottom of the page.



11. A completed vehicle information screen appears.

12. Select the **check mark**. You are now finished setting up the scan tool.

COPY CODING FROM ORIGINAL TCM TO MUT-III

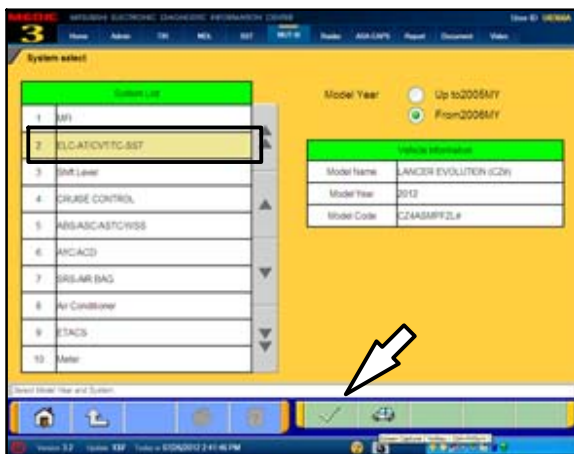

1. From the MUT-III Main Menu, click **System Select**.
2. Confirm the “**From2006MY**” button is selected and vehicle information matches the vehicle you are working on.
3. Highlight **ELC-AT/CVT/TC-SST** and click the **check mark**.

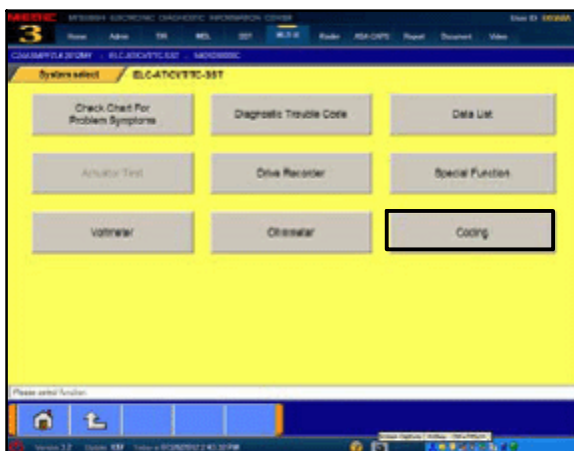

4. Click the **Coding** button.

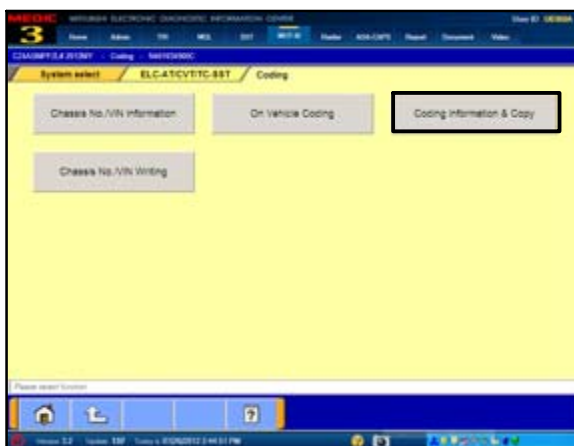

5. Click the **Coding Information & Copy** button.

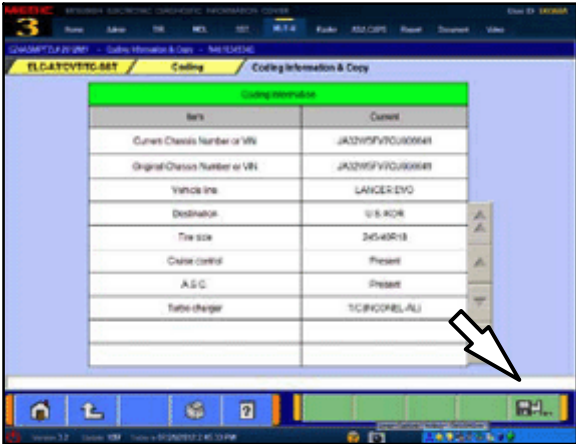

6. Click the **Computer Disc** button at the lower right corner of the screen.

!! IMPORTANT !! The CURRENT VIN must be correct for the vehicle.

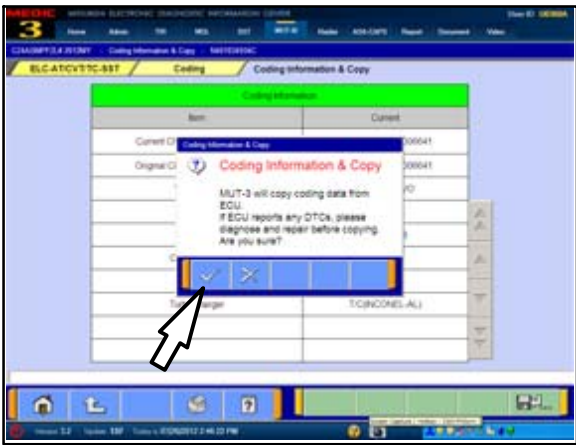

7. The **Coding Information & Copy** dialog box appears. Verify no DTC's exist in the system prior to saving this information.

If there is, the data you collect may be corrupt leading to future transmission problems once this data is uploaded to the replacement TCM.

Click the **check mark** to continue.

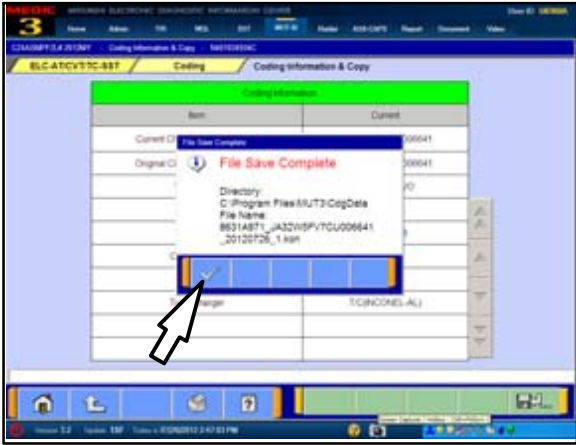

8. The **File Save Complete** dialog box appears. The file name contains the vehicle VIN along with the current date. Click the **check mark** to continue.

9. Click the "Home" icon at the bottom left of the page to return to the MUT-III main page.

10. Turn off ignition and disconnect MUT-III from the data link connector.

11. Replace Mechatronic Valve Body & TCM assembly. Instructions begin on next page.

MECHATRONIC ASSEMBLY REPLACEMENT PROCEDURES

The following is a general procedure for Mechatronic Assembly replacement. Refer to the applicable service manual for Pre-removal and Post-installation Operations, and review all Cautions and Warnings before proceeding.

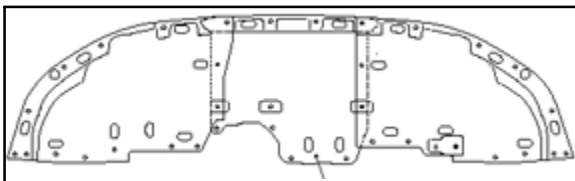

1. Record the customer's radio presets.
2. Disconnect the battery (—) terminal.
3. Remove center section of lower engine cover.

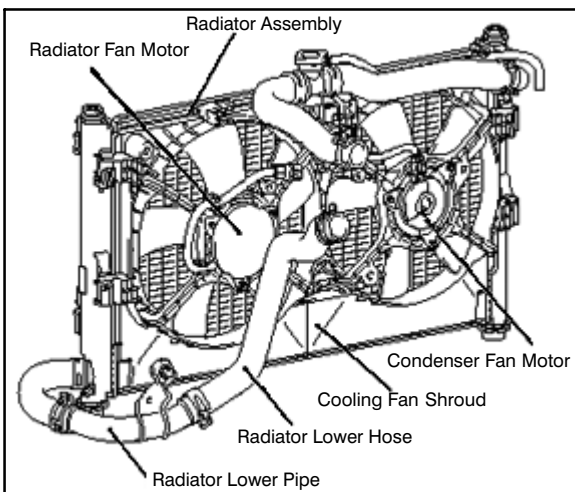

4. Loosen radiator drain plug. Drain coolant.

Drain coolant into a clean container. It will be reused for this procedure.

5. Remove lower radiator hose and pipe.
6. Remove fans, fan motors, and fan shroud.
7. Remove battery & tray (Ralliart only).

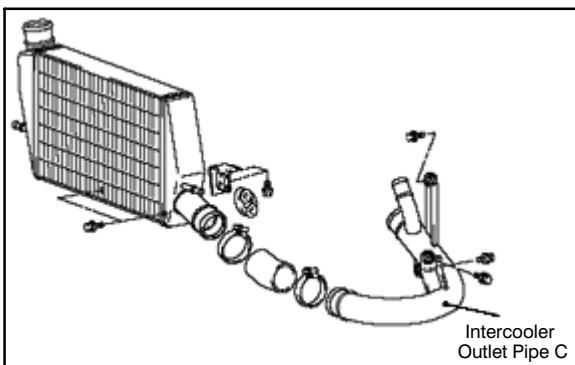

8. Remove Intercooler Outlet Pipe C.
9. Remove air cleaner element and intake duct.

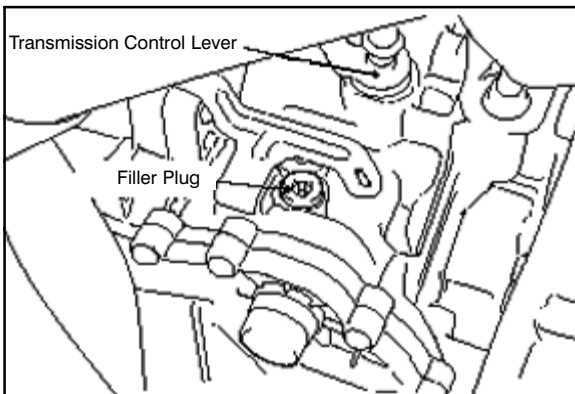

10. Remove filler plug on the top of the transmission.

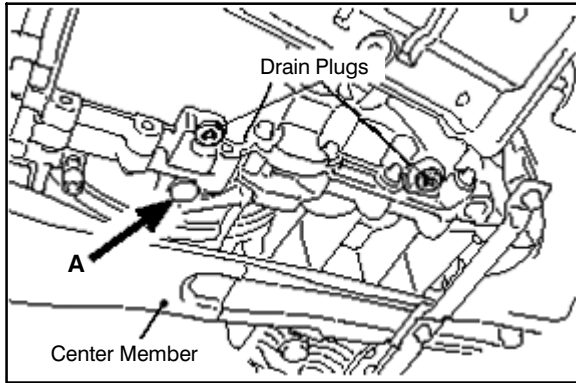

11. Remove drain plugs as shown at left and allow transmission fluid to drain for at least 3 minutes.

NOTE: If there is a plug located at point A, leave it installed.

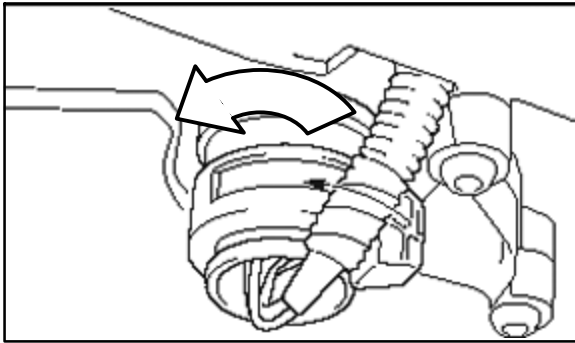

12. Rotate the transmission harness connector 90° and remove.

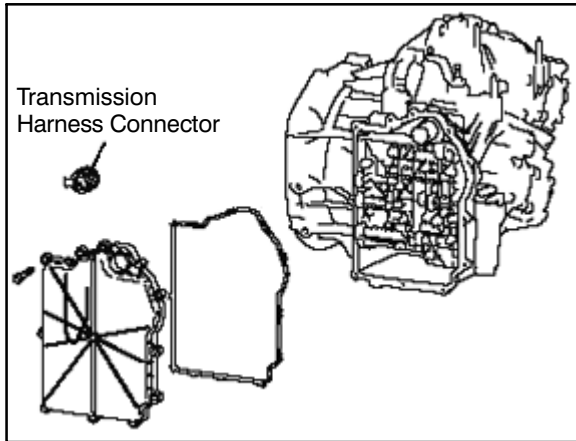

13. Remove and discard the transmission side cover and bolts. You will install a new side cover during reassembly.

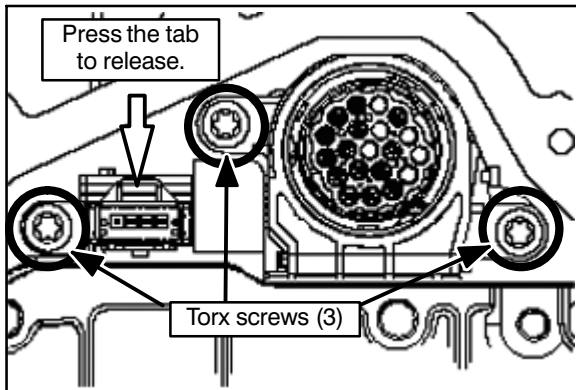

14. Using a small screwdriver to depress the release tab, carefully remove the internal 4-pin transmission electrical connector.

15. Remove 3 torx screws retaining the valve body connector. They can be discarded. New bolts for the connector are included with the new Mechatronic assembly.

16. Carefully unseat, but DO NOT attempt to remove, the connector.

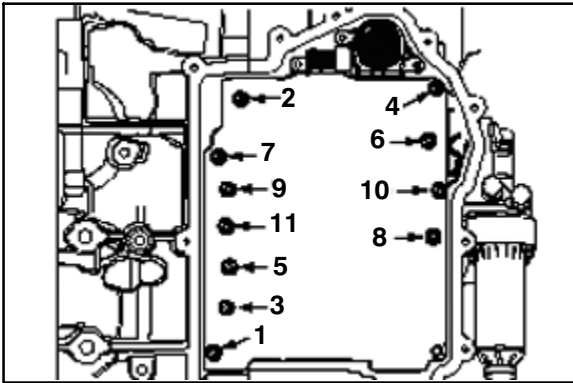

17. Remove the valve body bolts in the order shown. They can be discarded. New bolts for the valve body are included with the new Mechatronic assembly.
18. Carefully remove the Mechatronic assembly.

TAKE EXTRA CARE WHEN REMOVING THE VALVE BODY. THERE ARE LONG SENSORS THAT CAN BREAK. BROKEN PIECES CAN EASILY FIND THEIR WAY INTO THE TRANSMISSION.

19. Remove the left and right valve body gaskets.

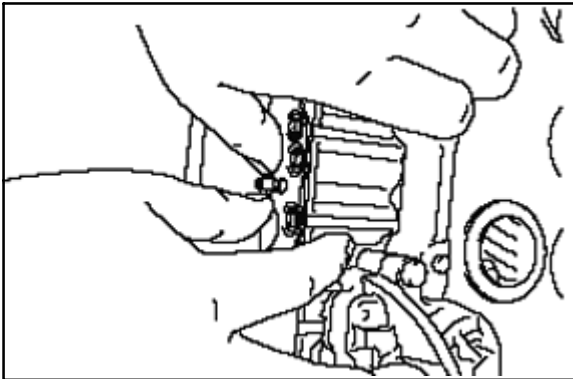

20. Clean and dry the valve body gasket surface.

NOTE: New valve body gaskets are included with the new Mechatronic assembly. They can only be installed in one direction.

21. Install the new left side (engine side) valve body gasket over the dowel pin.

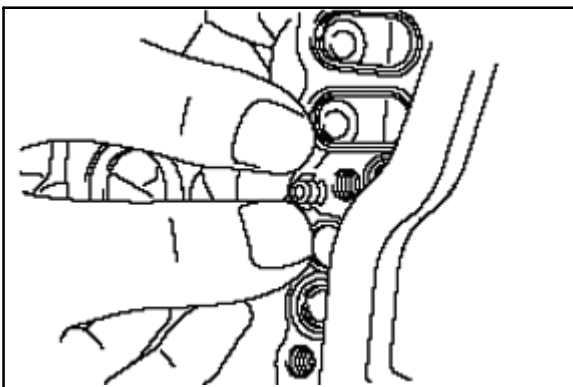

22. Install the new right side (external filter side) gasket over the dowel pin.

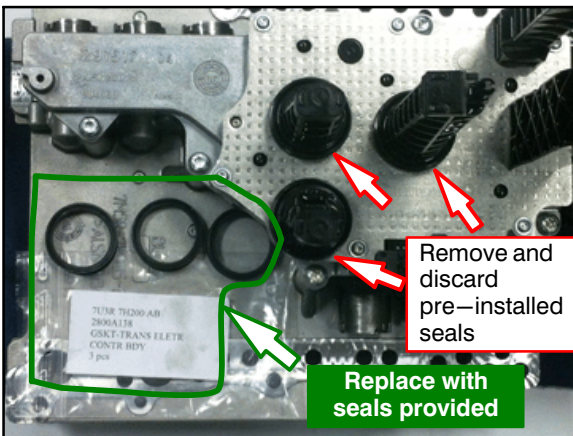

The new Mechatronic assembly is packaged with three seals pre-installed on the tall plastic sensors (see photo left).

REMOVE AND DISCARD THESE SEALS.

New seals (p/n 2800A138) are included with the new Mechatronic assembly, packaged in a plastic bag.

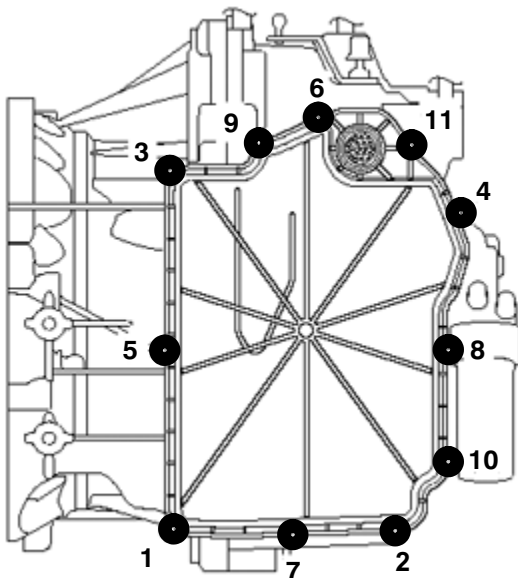
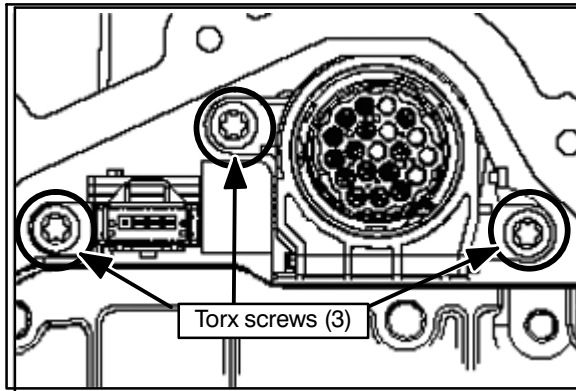
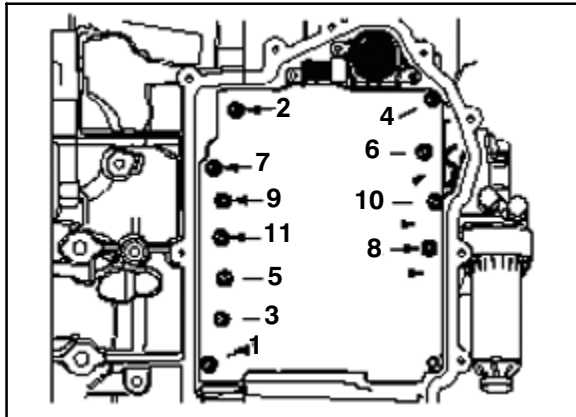

23. On the new valve body, thoroughly lubricate the replacement sensor seals with TC-SST fluid and install them to the valve body.
24. Install the new Mechatronic assembly to the transmission using new bolts included with the new Mechatronic assembly.

Make sure the small connector does not get trapped behind the valve body.

25. Torque mounting bolts in the sequence shown at left to **44 ± 8 in-lbs.**
26. Retorque mounting bolts in the sequence shown to **89 ± 8 in-lbs.**
27. Use new torx screws included with the new Mechatronic assembly to attach the valve body connector and **torque to 53 ± 8 in-lbs.**
28. Connect the 4 pin connector.

29. Install a **NEW** transmission side cover (p/n 2502A042) using new bolts included with the new cover. Torque to **89 ± 8 in-lbs** in the sequence shown at left.

30. Install the transmission harness connector.

31. Install drain plugs. **Torque to 26 ± 4 ft.-lbs.**

32. Install a new external transmission oil filter (p/n 2513A040). **Torque to 11 ± 1 ft lb.**

33. Fill the transmission with 5.8 quarts of DiaQueen SSTF-1 (p/n C0002610). **Tighten filler plug to 26 ± 4 ft=lbs.**

34. Install air cleaner element and intake duct.

35. Install intercooler outlet pipe.

36. Install battery and tray (Ralliart only). Reconnect battery (—) terminal (all).

37. Reinstall lower radiator hose, fans, fan motors shroud. Refill radiator with saved coolant.

38. Reinstall the engine undercover center section.

39. Restore customer's audio presets and reset the clock.

PROGRAM NEW TRANSMISSION CONTROL MODULE (TCM)

Use the following table to select the correct software when when performing TCM reprogramming during step 19 of this procedure.

REPROGRAMMING DATA LIST

Database No. *N16031*

Vehicle Model Number	Model Year	File Name	S/W Part Number
CZ4A (Lancer Evolution)	2008	8631B413.cff	8631A3790E
	2009	8631B001.cff	8631A8270B
	2010	8631B001.cff	8631A8270B
	2011 – 2015	8631B151.cff	8631A9710A
CY4A / CX4A (Lancer & Lancer Sportback Ralliart)	2009	8631B002.cff	8631A8600B
	2010	8631B002.cff	8631A8600B
	2011 – 2015	8631B152.cff	8631A9720A

CONNECT A BATTERY CHARGER TO THE VEHICLE'S BATTERY DURING THE REMAINING INSTRUCTIONS. DO NOT ALLOW THE BATTERY CHARGER TO TIME OUT. BATTERY VOLTAGE (AS MEASURED AT THE BATTERY POSTS WITHOUT ELECTRICAL LOAD) MUST BE KEPT AT 12.4V OR HIGHER IN ORDER TO REPROGRAM THE ECM. MEASURE THE BATTERY VOLTAGE AND CHARGE AS NECESSARY.

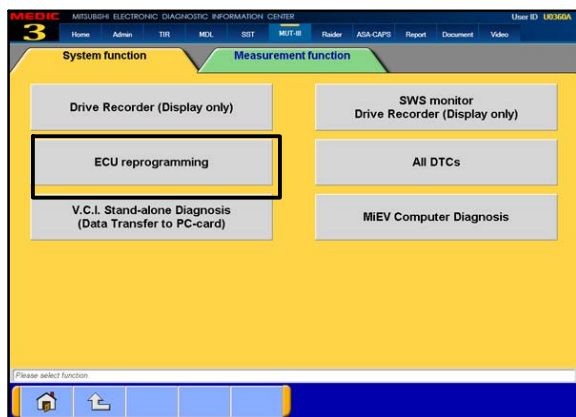

1. On the MUT-III Main Menu, click **Special Function**.
2. Click **ECU reprogramming**.

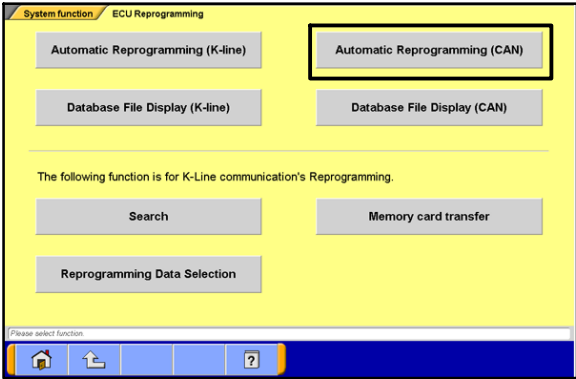

3. Click **Automatic Reprogramming (CAN)**.

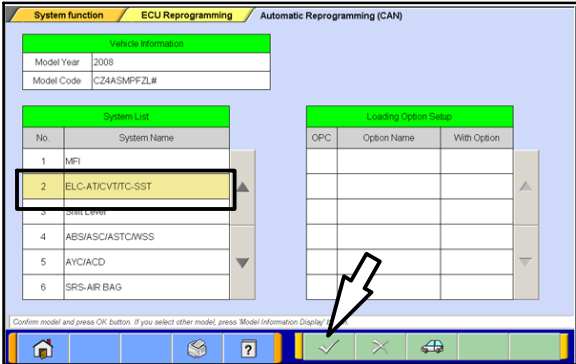

4. Select **ELC-AT/ CVT/ SST** and click the **check mark** to continue.

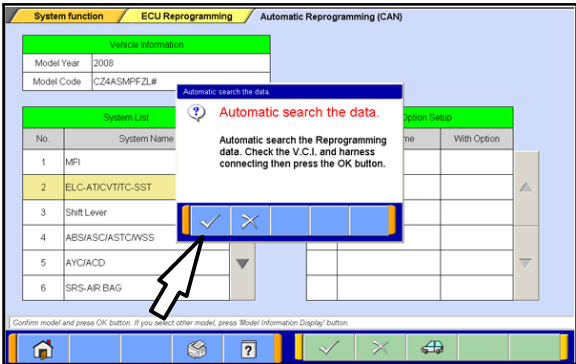

5. In the “Automatic search the data” dialog box, click the **check mark** to begin a search for reprogramming data.

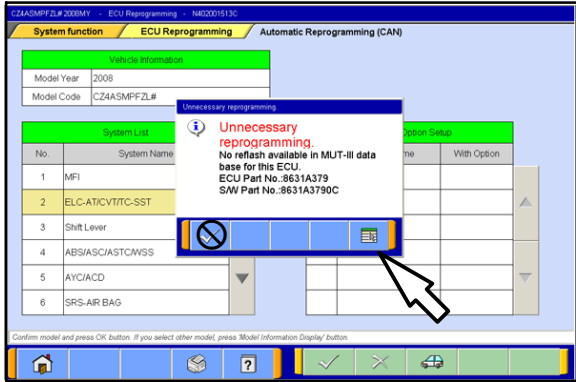

6. In the “Unnecessary Reprogramming” dialog box, click the **Data Screen icon (not the check mark)**.

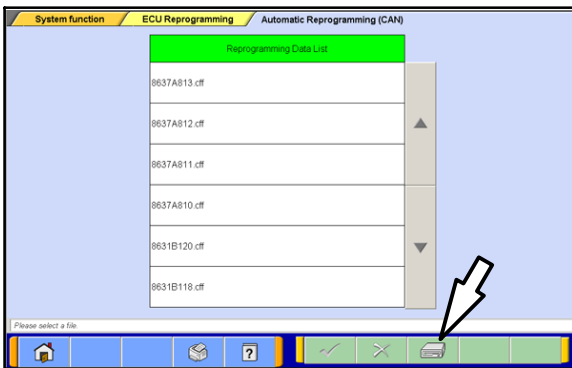

7. Once the **Automatic Reprogramming (CAN)** screen appears, all data contained in the data storage system is displayed.

To access the needed TC-SST data, Click the **Data Drive icon** at the bottom of the screen.

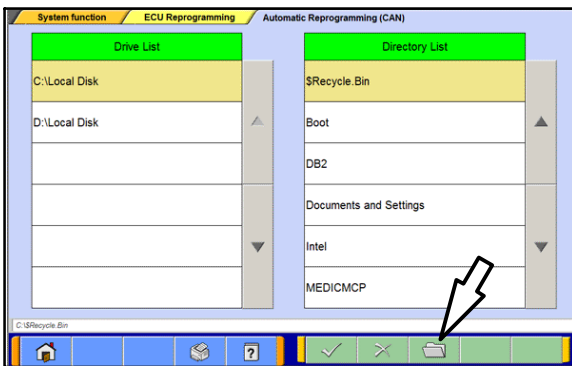

8. Click on the **file folder icon** at the bottom of the screen.

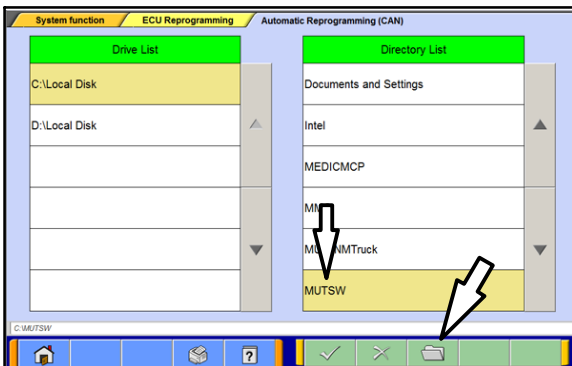

9. Scroll down the **Directory List** until **MUTSW** is displayed.

10. Select **MUTSW** and click the **file folder icon** at the bottom of the screen.

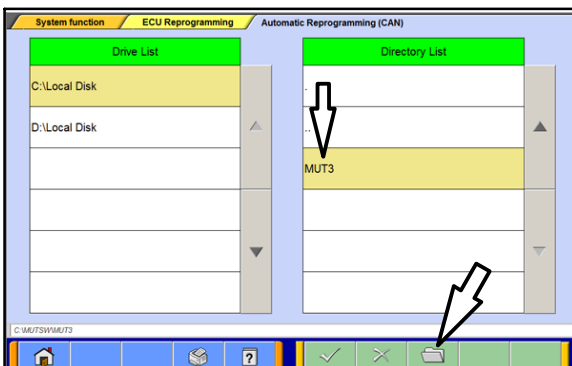

11. Scroll down the **Directory List** until **MUT3** is displayed.

12. Select **MUT3** and click the **file folder icon**.

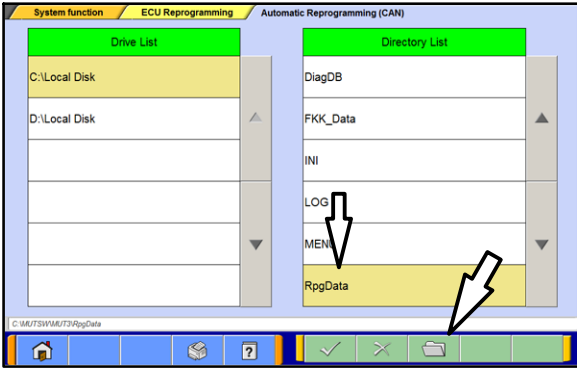

13. Scroll down the **Directory List** until **RpgDtata** is displayed.

14. Select **RpgDtata** and click the **file folder** icon.

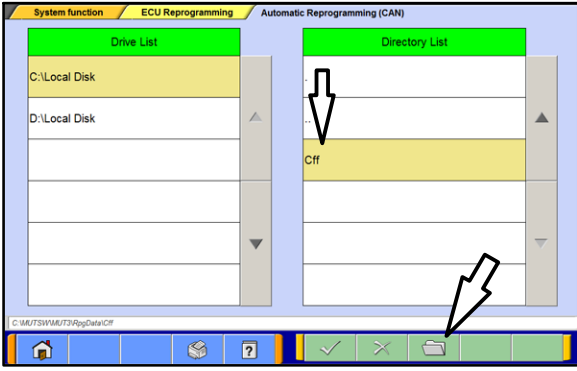

15. Select **CFF** and click the **file folder** icon.

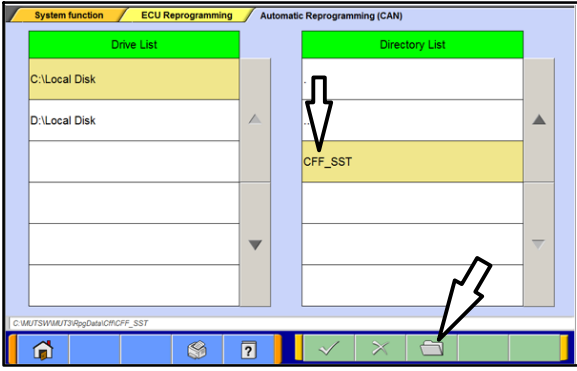

16. Select **CFF_SST** and click the **file folder** icon.

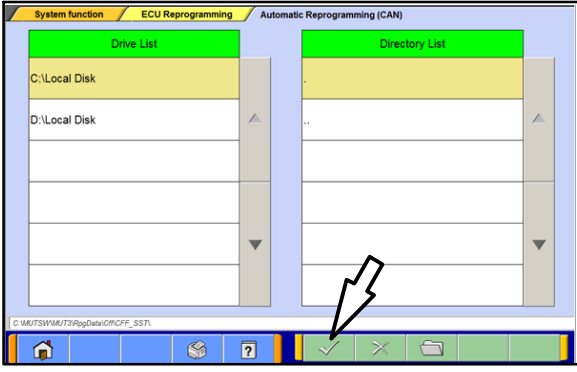

17. Once the **Directory List** is blank, click the **check mark** to continue.

MITSUBISHI MOTORS CORPORATION

MODEL

ENGINE EXT

TRANS AXLE

COLOR INT OPT

18. Determine the first 4 characters of the Vehicle Model Number (shown on the Vehicle Identification Code plate attached to the passenger's side B pillar).

Example: CY4A

19. Using the Vehicle Model Number and Model Year information from the Database table at the beginning of this section (page 18), determine the correct File Name for reprogramming.

!! IMPORTANT !!

BEFORE PERFORMING ANY FURTHER STEPS, READ THE NEXT STEP COMPLETELY.

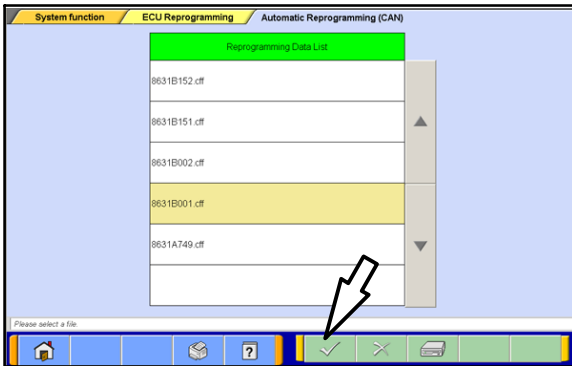

20. Based on information from the previous step, select the correct file from the **Reprogramming Data List** and click the **check mark** to continue.

IMPORTANT NOTE:

If the vehicle is a 2008 Lancer Evolution, install 8631B001.cff instead of 8631B413.

YOU WILL REPLACE 8631B001 WITH THE CORRECT FILE AFTER TEACH-IN IS COMPLETED.

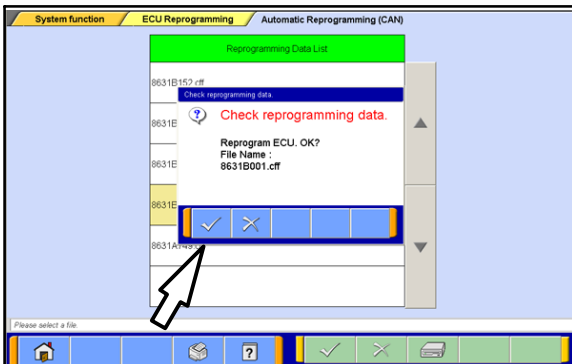

21. Click the **check mark** in the **Check Reprogramming Data** dialog box to continue.

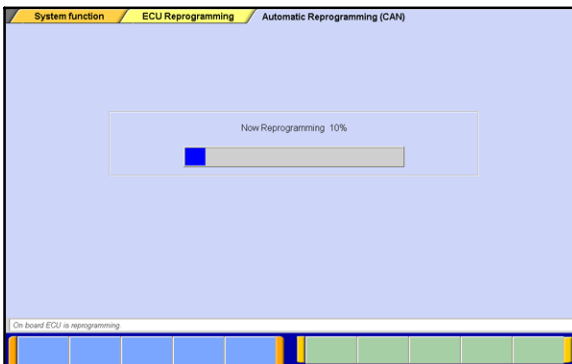

22. Data will load from MUT-III to the TCM.

NOTE: This process takes approximately seven minutes to complete.

CAUTION The Daytime Running Lights and both the engine and condenser fans will automatically be turned on during reprogramming. Care should be taken to insure nothing gets caught in the moving blades. The radio will be turned off and you will also hear a chime in the interior for a short period of time. These are normal conditions.

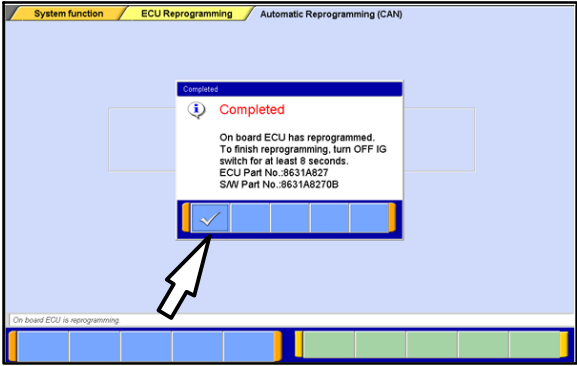

23. Once programming is finished, the **Completed** dialog box is displayed.

NOTE: Confirm the TCM part number and software part number match the choices made in *steps 20 through 22*.

Click the **check mark** to continue.

24. Turn the ignition to LOCK (OFF) position for at least 8 seconds.

25. Continue to TCM VIN Writing procedures listed below.

VIN WRITING TO THE NEW TRANSMISSION CONTROL MODULE (TCM)

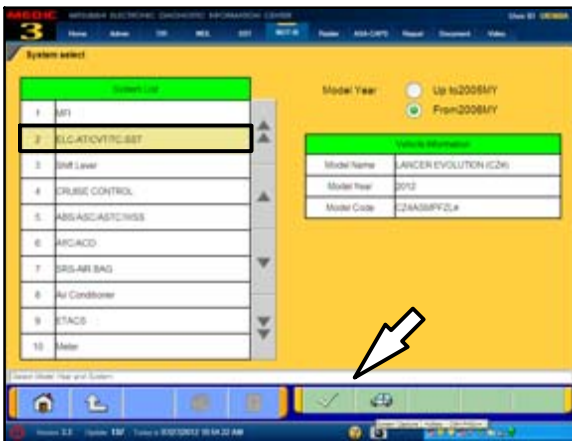

1. Turn the ignition to the ON (RUN) position.
2. From the MUT-III Main Menu, click **System Select**.
3. Select **ELC-AT/CVT/TC-SST** from the **System List** and click the **check mark** to continue.

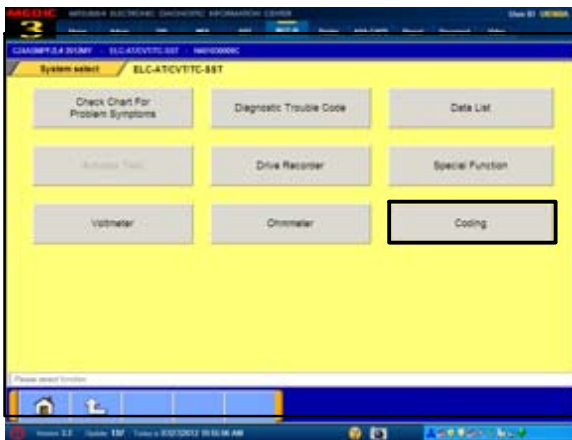

4. Click the **Coding** button.

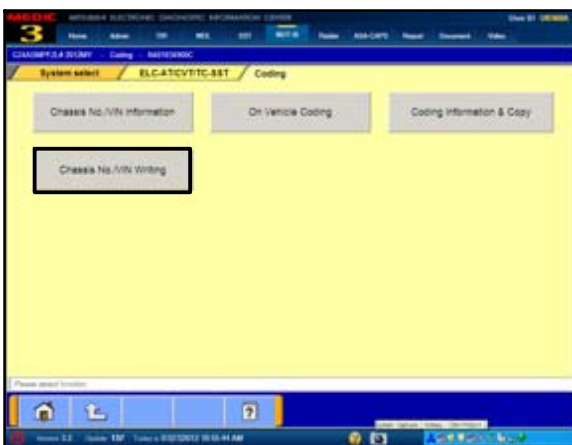

5. Click the **Chassis No./VIN Writing** button.

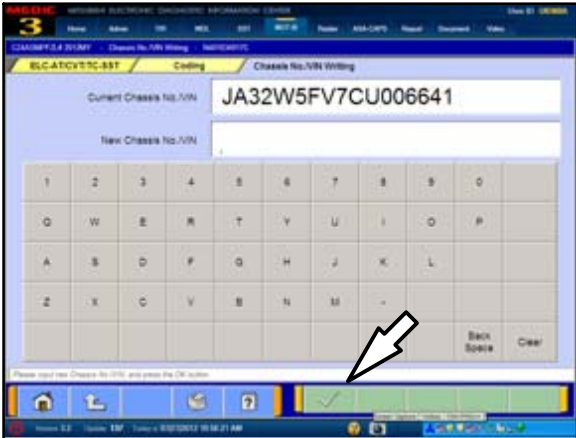

6. Type in the 17 digit VIN. There is no option to have MUT-III auto fill the VIN for you.

Double check the VIN before proceeding.

Click the **check mark** to continue.

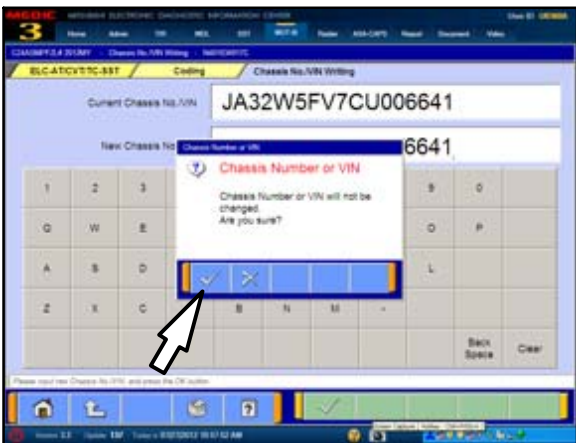

7. Click the **check mark** in the **VIN Writing** dialog box to continue.

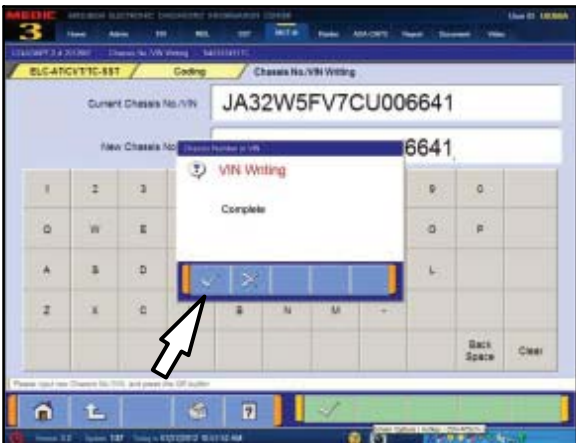

8. Click the **check mark** in the **VIN Writing** dialog box when **Completed** is displayed.

9. Proceed to **Copy Coding from MUT-III to Replacement TCM** beginning on the next page.

COPY CODING FROM MUT-III TO REPLACEMENT TCM

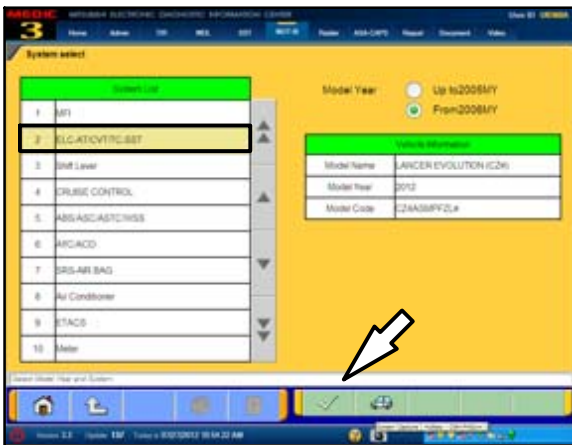

1. Click the **ELC-AT/CVT/TC-SST** button.
2. Click the **check mark** to continue.

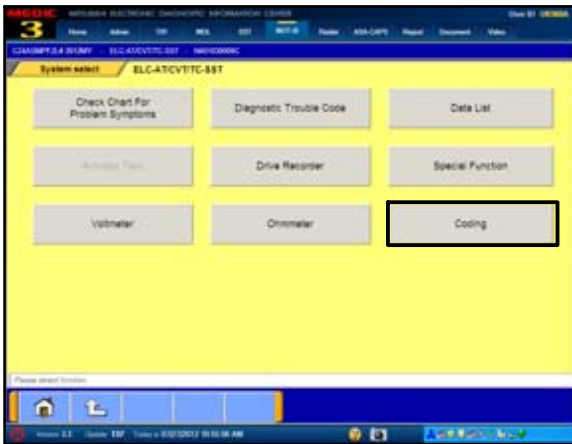

3. Click the **Coding** button.

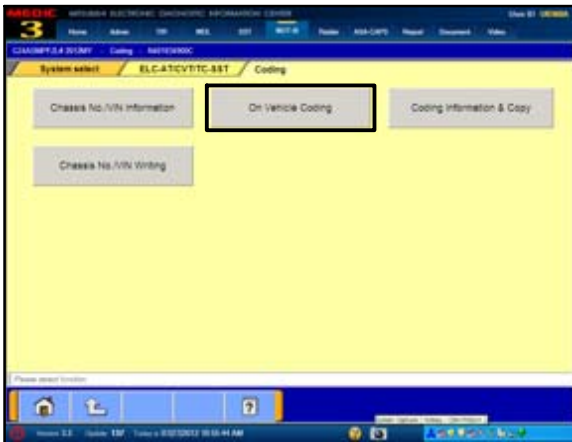

4. Click the **On Vehicle Coding** button.



5. Click the **check mark** in the **On Vehicle Function** dialog box to continue.

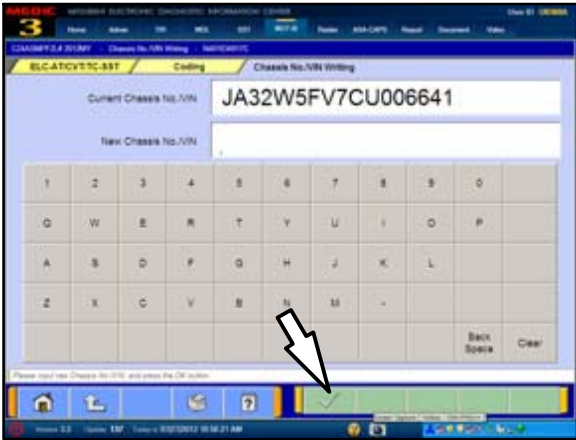

6. Type in the 17 digit VIN. There is no option to have MUT-III auto fill the VIN for you.

Double check the VIN before proceeding.

7. Click the **check mark** to continue.

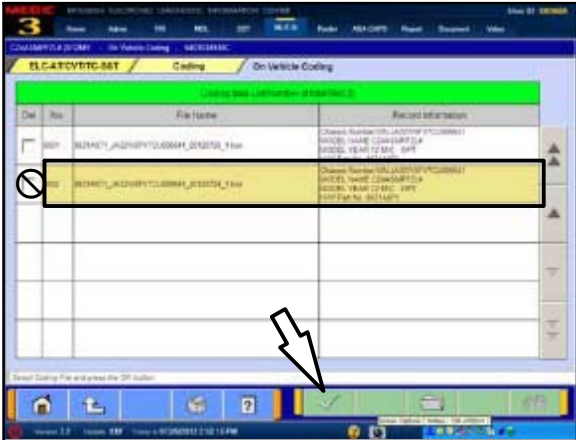

8. Highlight the correct file based on the VIN and date when the Copy Coding began.

NOTE: Highlight the file only as shown. DO NOT check the box in the "DEL" column. Doing so will delete the file when the check mark is clicked.

9. Click the **check mark** to continue.

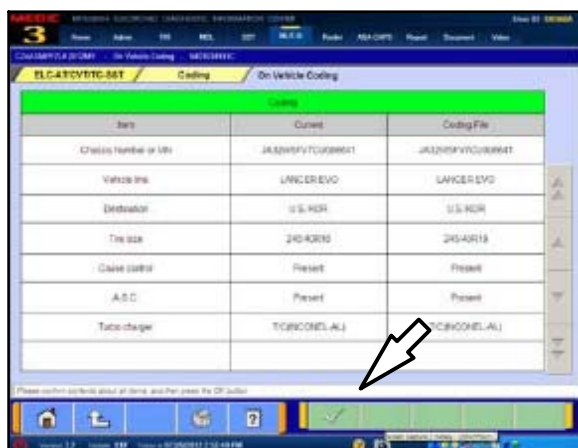

10. Compare the **Current** and **Coding** files. They should match each other.

11. Click the **check mark** to continue.

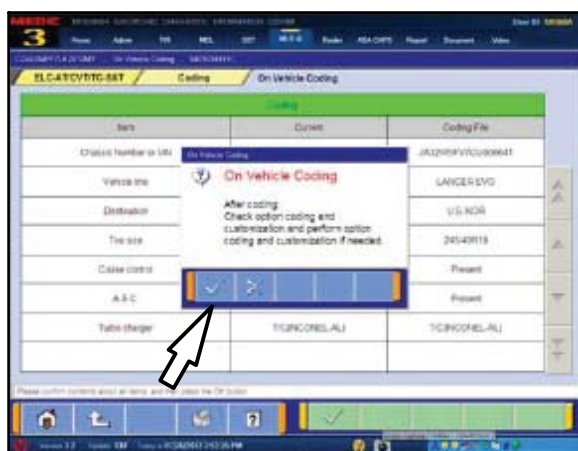

12. Click the **check mark** in the **On Vehicle Coding** dialog box.

NOTE: If Download Coding was performed instead of Copy Coding, be certain to select the proper port or dealer installed accessories. DTCs may be set and accessory operation may be affected if not correctly selected.

13. Click the **check mark** in the dialog box to continue

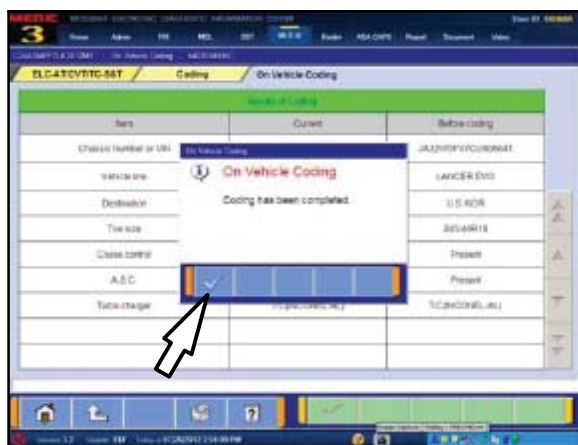

14. Click the **check mark** in the **On Vehicle Coding** dialog box when coding is complete.

15. Continue to the Teach-In procedure that follows.

PERFORM “TEACH-IN” PROCEDURE ON NEW TCM

WARNING During the “Teach-in” procedures that follow, **DO NOT** allow anyone to stand in front of the vehicle. Even though these procedures will not run unless the brake pedal is depressed and the parking brake is on, **ALWAYS** use common sense and observe proper safety practices.

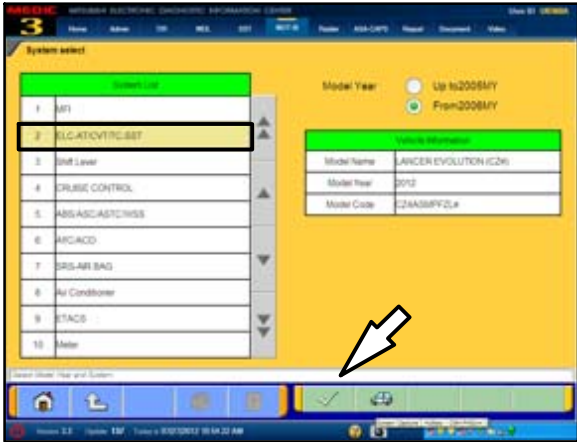

1. Start the engine and **FIRMLY** apply the **parking brake AND service brake**.
2. From the MUT-III Main Menu, click **System Select**.
3. Click the **ELC-AT/CVT/TC-SST** button.
4. Allow the engine to idle until transmission temperature reaches 104° to 176°F.
NOTE: Warming transmission temperature can take 20 minutes or longer.
5. Select **Data List** and monitor **Data item # 55: Transmission temperature sensor** to confirm transmission temperature.

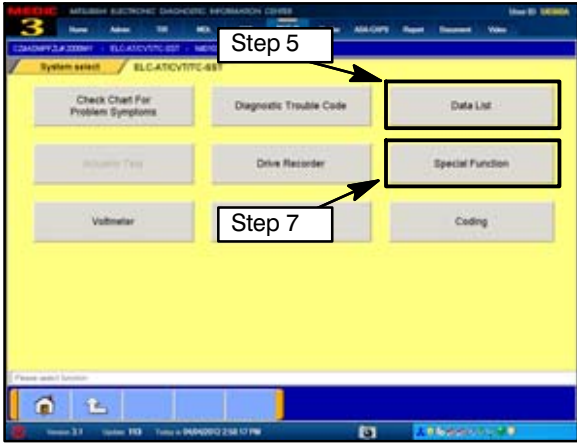

6. Click the **check mark** to continue.
7. Click the **Special Function** button.

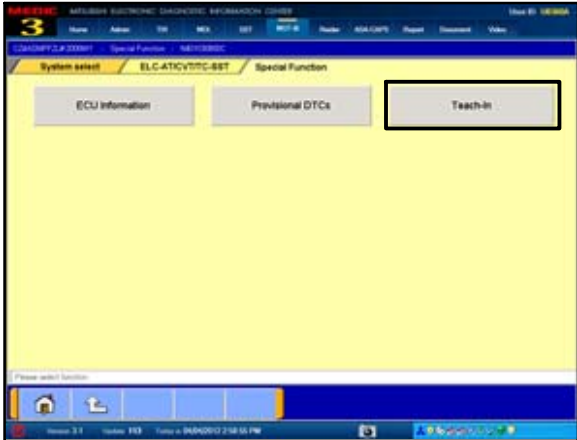

8. Click the **Teach-in** button.
NOTE: After a Mechatronic assembly is replaced, you must complete two Teach-in procedures (Shift Fork Teach-in and Clutch Teach-in).

These procedures incorporate eight individual **Selected Commands**.

9. Click the **pull down arrow** to expand the **Selected Command** column.

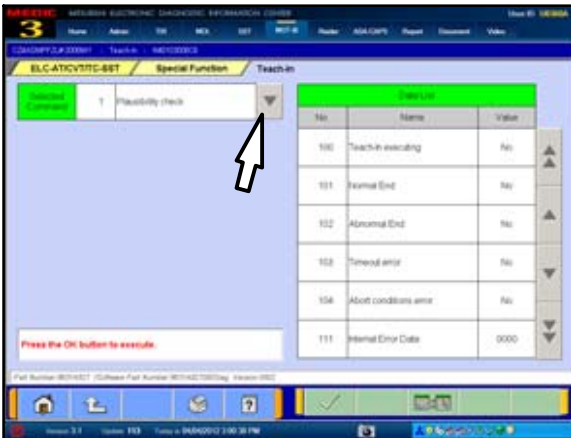

Teach-In Selected Commands.

1. Plausibility Check
2. Shift Fork Teach In
3. Line Pressure Test
4. Stroke Teach-In
5. Boost Teach-In
6. Interlock Teach-in
7. Clutch Ventilation
8. Reset Clutch Gain

Commands must be executed in a specific order, (described later in this TSB) for Mechatronic Teach-in to be completed successfully.

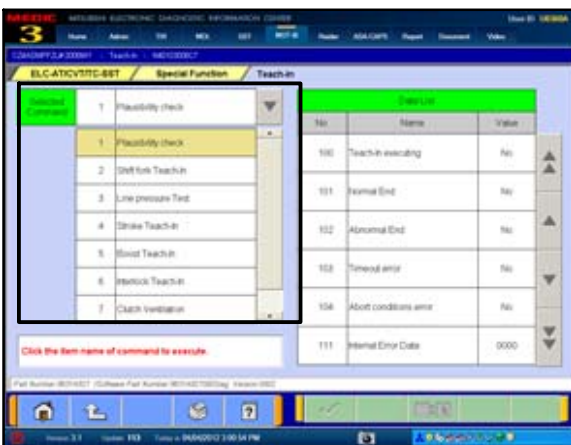

Note the 7 **Data List** items which correspond to each **Selected Command**. These indicate the status of each Teach-In segment.

The expected results after each successful Teach-In segment are shown in parenthesis next to the Data List item.

100. Teach-In Executing (NO)
101. Normal End (YES)
102. Abnormal End (NO)
103. Timeout Error (NO)
104. Abort Conditions Error (NO)
110. Execute Last Teach-In item (last item)
111. Internal Error Data (NO)

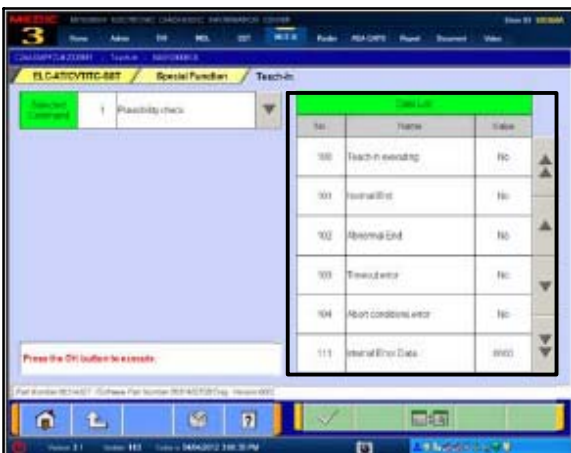

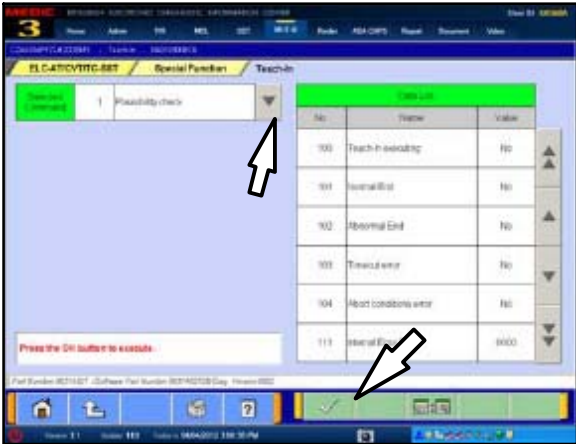

10. Select **Plausibility Check** and click the **check mark** to continue.

NOTE: The Selected Command menu will collapse once a command is selected.

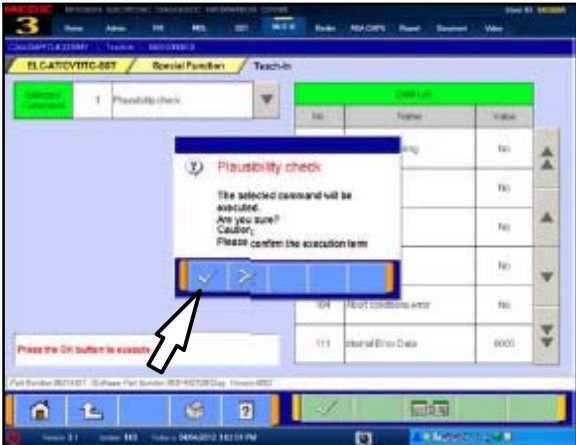

11. Click the **check mark** in the **Plausibility Check** dialog box to confirm.

NOTE: The engine speed briefly increases to about 1500 RPM and returns to idle during the Plausibility Check.

- If Normal End (NO) is displayed, repeat this step.
- If you continue to have Normal End (NO) returned, contact Techline.

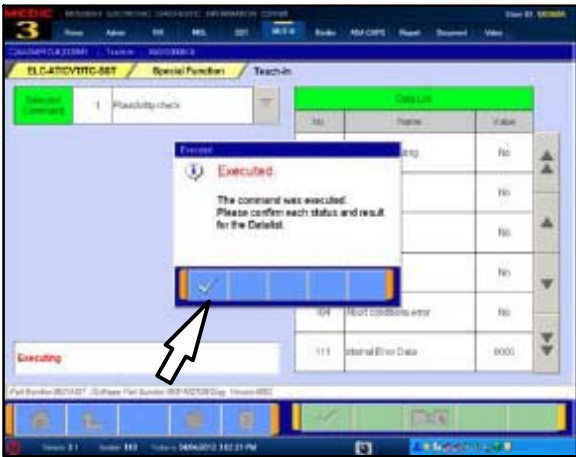

12. When the procedure is complete, the **Executed** dialog box advises Selected Command 1 Plausibility Check was completed and requests confirmation of the results in the Data List Column.

- Click the **check mark**.
- Before continuing to Step 13, confirm Data List No. 101 Normal End (YES) is displayed for the Plausibility Check.
- If Normal End (NO) is displayed, repeat this step. If you continue to have Normal End (NO) returned, contact Techline.

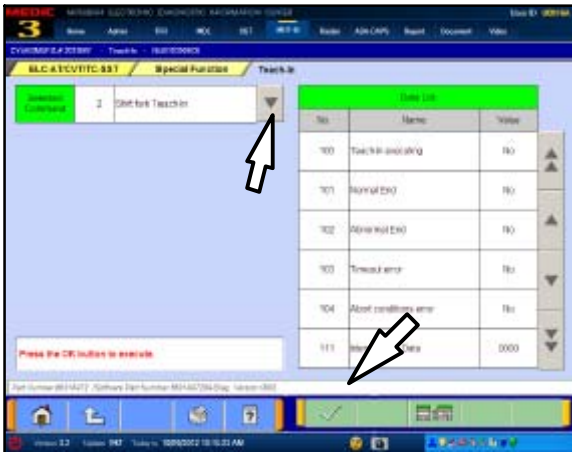

13. Click the Selected Command **down arrow** and choose **Shift Fork Teach—In**.

- Click the **check mark** to continue.
- Click the **check mark** in the **Shift Fork** dialog box to confirm execution of this Teach—In Segment.

NOTE: Do not press the check mark until the Shift Fork Teach—In is complete.

- When the procedure is complete, the engine returns to idle and the Executed dialog box advises that Selected Command 2 Shift Fork Teach—In was completed and requests confirmation of the results in the Data List column.
- Before continuing, confirm Data List No. 101 Normal; End (YES) is displayed for the Shift Fork Teach—In.
- If Normal End (NO) is displayed, repeat this step.
- If you continue to have Normal End (NO) returned, contact Techline.

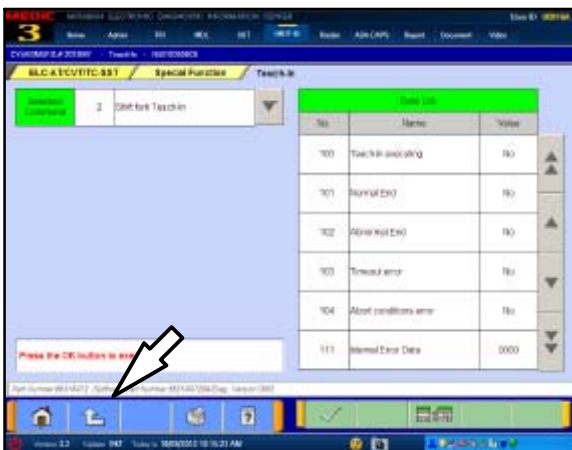

14. Click the back button (up arrow) once to return to the **Special Function** Screen.

15. Turn ignition switch to LOCK (OFF).

This concludes the Shift Fork Teach—In.

Continue to Clutch Teach—In beginning at step 16.

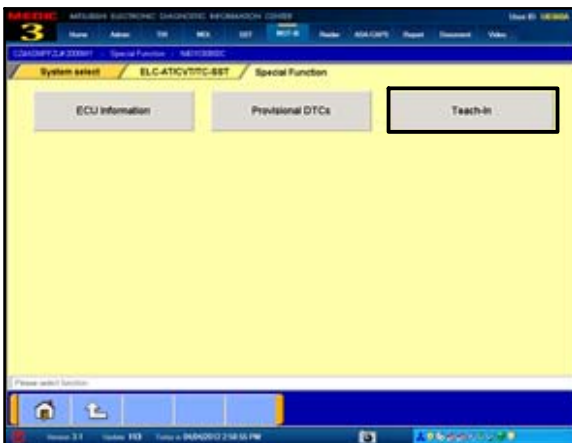

16. With the parking brake set, brake pedal depressed, and shift lever in P, start the engine and allow it to idle.

17. Return to the ELC—AT/CVT/TC—SST Special Function page.

18. Click the **Teach—In** button.

!! IMPORTANT !!

From this point forward, Selected Commands must be completed **exactly** in the following order. **Do not deviate from the order shown.**

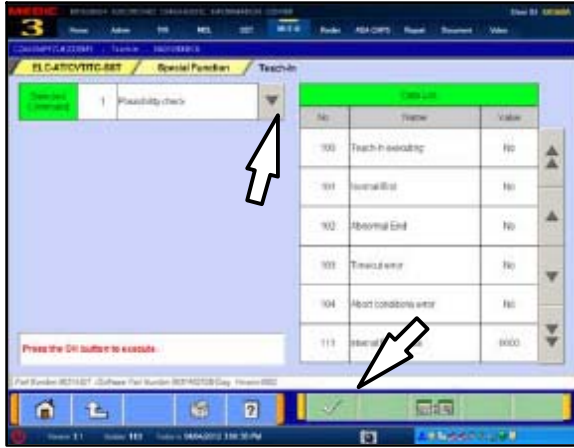

19. Select **Plausibility Check** from the Selected Command column. **REPEAT Plausibility Check for Clutch Teach-In. Do not omit this step.**

- Before continuing, confirm Data List No. 101 Normal; End (YES) is displayed for the Shift Fork Teach-In.
- If Normal End (NO) is displayed, repeat this step.
- If you continue to have Normal End (NO) returned, contact Techline.

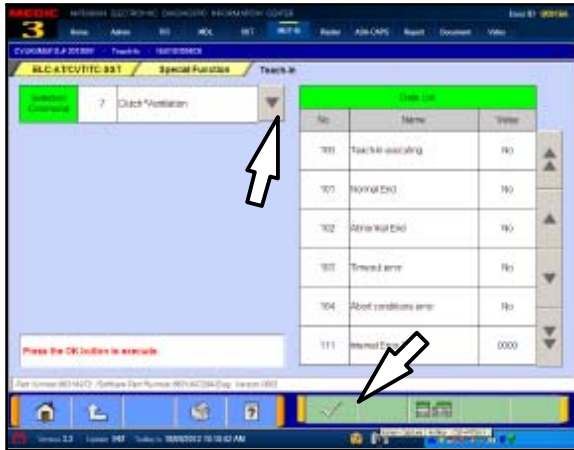

20. Choose Selected Command 7 **Clutch Ventilation** from the pull down menu.

- Click the **check mark** to continue.
- Execute the command and confirm its proper completion by verifying Data Item No. 101 Normal End indicates YES.
- If Normal End (NO) is displayed, repeat this step.
- If you continue to have Normal End (NO) returned, contact Techline.

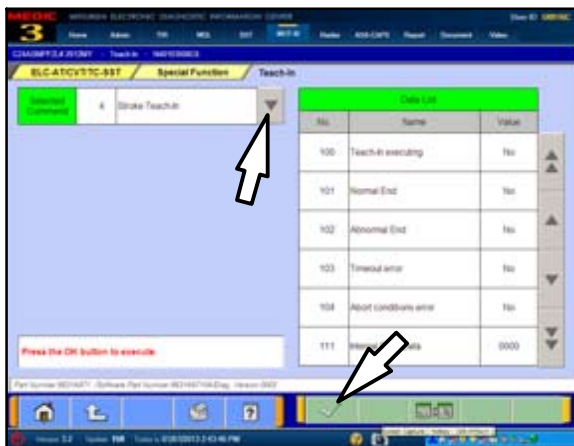

21. Choose Selected Command 4 **Stroke Teach-In**.

- Click the **check mark** to continue.
- Execute the command and confirm its proper completion by verifying Data Item No. 101 Normal End indicates YES.
- If Normal End (NO) is displayed, repeat this step.
- If you continue to have Normal End (NO) returned, contact Techline.

⚠ WARNING

During the “Boost Teach-in” procedure that follows, **DO NOT** allow anyone to stand in front of the vehicle. Even though the procedure will not run unless the brake pedal is depressed and the parking brake is on, **ALWAYS** use common sense and observe proper safety practices .

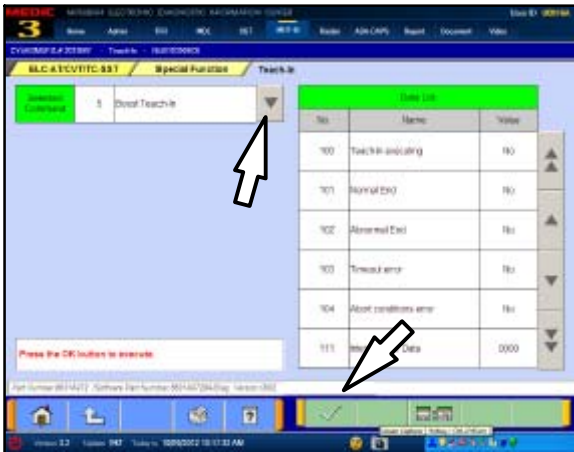

22. Confirm the parking brake AND service brake are **FIRMLY** applied.

23. Choose **Boost Teach-In** from the pull down menu.

NOTE: Engine speed accelerates to **4000 RPM** twice during this procedure. The first increase occurs approximately 17 seconds after the check mark is pressed. This is normal.

- Click the **check mark** to continue.
- Execute the command and confirm Data Item No. 101 Normal End indicates YES.
- If Normal End (NO) is displayed, repeat this step.
- If you continue to have Normal End (NO) returned, contact Techline.

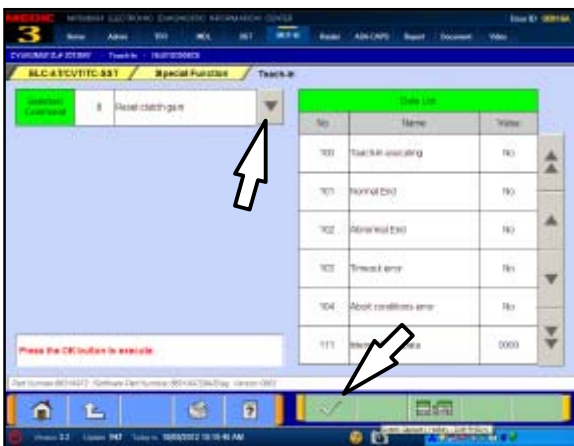

24. Choose **Reset Clutch Gain** from the pull down menu.

NOTE: This is the only Teach-In step which does not elevate engine speed. RPM remains at idle.

NOTE: If TCM software is 0001 (unlike example at left), reset Clutch Gain will not appear in the Selected Command column and does not need completion.

- Execute the command and confirm its proper completion by verifying Data Item No. 101 Normal End indicates YES.
- If Normal End (NO) is displayed, repeat this step.
- If you continue to have Normal End (NO) returned, contact Techline.



This completes **Clutch Teach-In**.

25. Turn the ignition switch to the LOCK (OFF) position.

For **2009 and later vehicles**, the repair and programming procedures are complete. Turn the ignition to the LOCK position, disconnect the MUT-III and the battery charger and proceed to the Quality Control Checklist at the end of this TSB to verify repairs.

If the vehicle is a 2008 Lancer Evolution, continue with **REPROGRAM 2008 LANCER EVOLUTION TCM WITH CORRECT SOFTWARE**.

REPROGRAM 2008 LANCER EVOLUTION TCM WITH CORRECT SOFTWARE

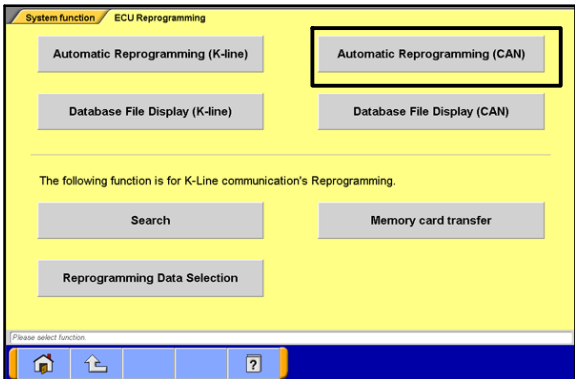

This procedure is only done AFTER all previous instructions have been completed.

1. On the MUT-III Main Menu, click the **Special Function** button.
2. Click the **ECU Reprogramming** button.
3. Click the **Automatic Reprogramming (CAN)** button.

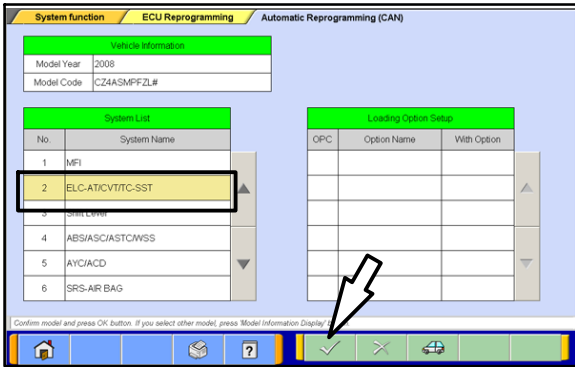

4. Select **ELC-AT/CVT/SST** and click the **check mark** to continue.

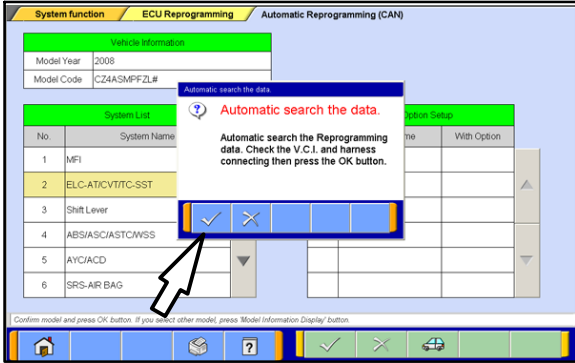

5. In the "Automatic search the data" dialog box, click the **check mark** to begin a search for reprogramming data.

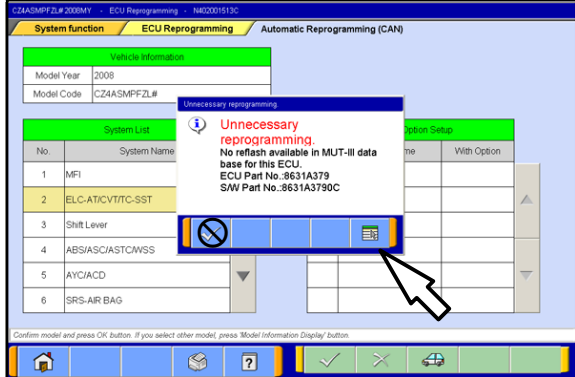

6. In the "Unnecessary Reprogramming" dialog box, click the **Data Screen icon (not the check mark)**.

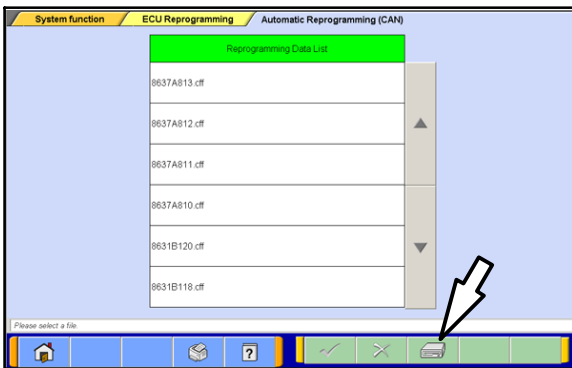

7. Once the **Automatic Reprogramming (CAN)** screen appears, all data contained in the data storage system is displayed.

To access the needed TC-SST data, Click the **Data Drive icon** at the bottom of the screen.

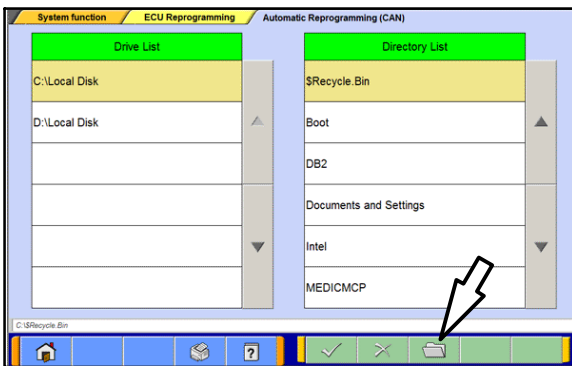

8. Click on the **file folder** icon at the bottom of the screen.

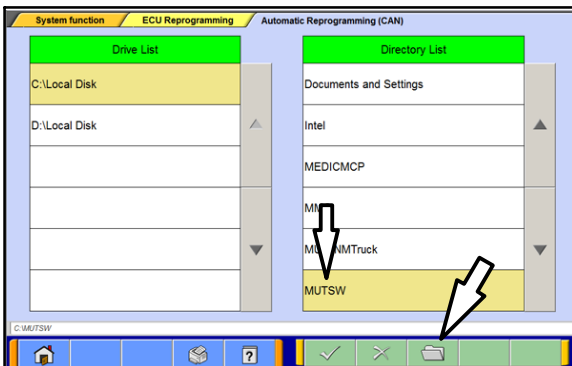

9. Scroll down the **Directory List** until **MUTSW** is displayed.

10. Select **MUTSW** and click the **file folder** icon at the bottom of the screen.

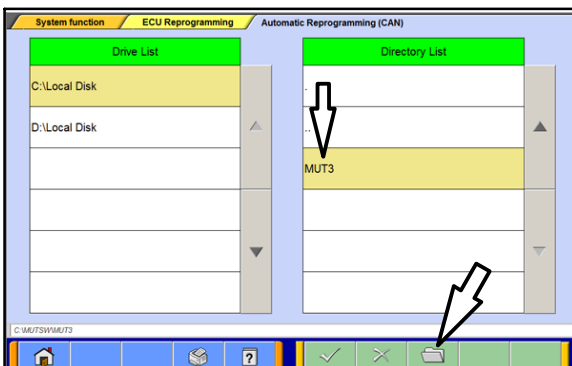

11. Scroll down the **Directory List** until **MUT3** is displayed.

12. Select **MUT3** and click the **file folder** icon.

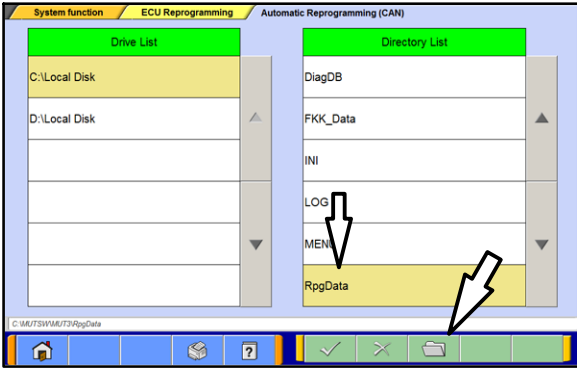

13. Scroll down the **Directory List** until **RpgDtata** is displayed.

14. Select **RpgDtata** and click the **file folder** icon.

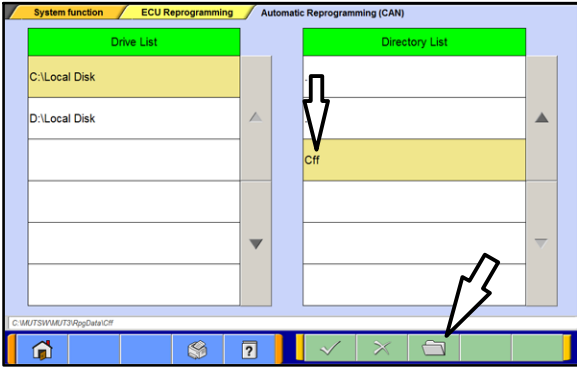

15. Select **CFF** and click the **file folder** icon.

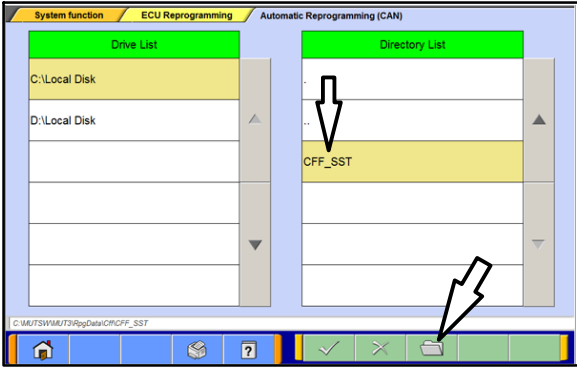

16. Select **CFF_SST** and click the **file folder** icon.

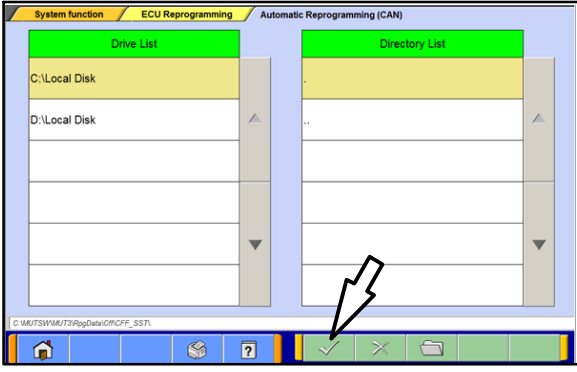

17. Once a blank **Directory List** is displayed, click the **check mark** to continue.



18. Select file 8631B413.cff from the **Reprogramming Data List** and click the **check mark** to continue.

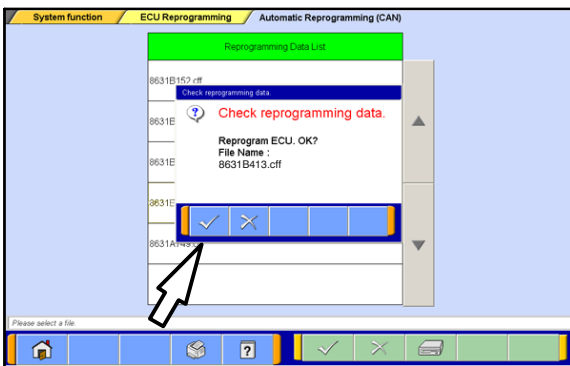

19. Click the **check mark** in the **Check Reprogramming Data** dialog box to continue.

CAUTION

The Daytime Running Lights and both the engine and condenser fans will automatically be turned on during reprogramming. Care should be taken to insure nothing gets caught in the moving blades. The radio will be turned off and you will also hear a chime in the interior for a short period of time. These are normal conditions.

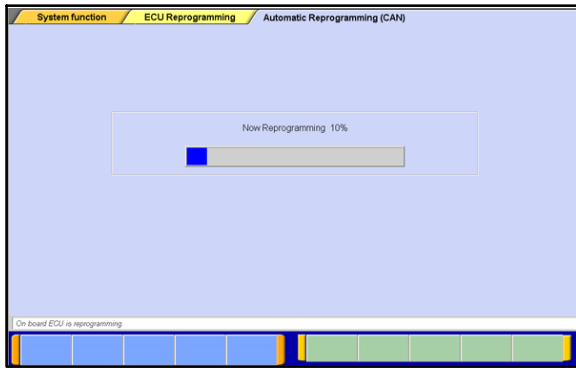

20. Data will load from MUT-III to the TCM.

NOTE: This process takes approximately seven minutes to complete. A battery charger should be attached to the vehicle battery and the MUT III should be plugged into its charger to prevent the program from stopping prior to completion.

Stopping prior to completion could permanently damage the TCM.

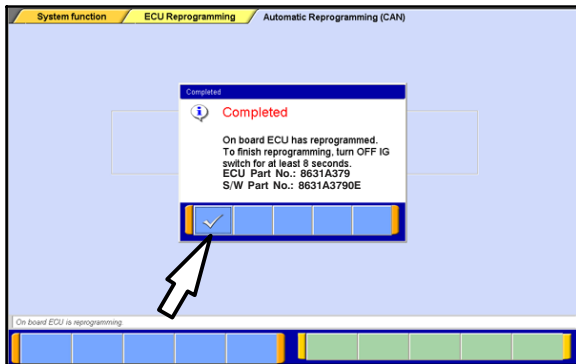

21. Once programming is completed, the **Completed** dialog box is displayed.

22. Confirm the S/W Part No. displayed is 8631A3790E.

23. Repair and programming procedures for a **2008 Lancer Evolution** are complete. Turn the ignition to the LOCK position, disconnect the MUT-III and the battery charger and proceed to the Quality Control Checklist at the end of this TSB to verify repairs.

QUALITY CONTROL CHECKLIST

- Mitsubishi SSTF1 fluid installed? YES NO
- Start engine. Is Check Engine Light (MIL) illuminated?
If YES, correct as necessary.
 - Check for DTCs in any ECU?
If YES, correct as necessary.
- Check for transmission oil leaks. YES NO
- Correct Software installed in TCM? YES NO
- Teach-In is completed? YES NO
- Road Test
Shift through all gears in both Automatic and Manual Modes.
Manual mode is slightly more deliberate/harsh compared to Automatic mode.
 - Any slippage noted? YES NO
 - Shift delays noted? YES NO
 - If YES, correct as necessary.
- Check for unusual noises in all gears while driving.
(Some noises, especially during shifting, are normal.)
 - Unusual noises on acceleration or deceleration? YES NO
 - Unusual noises while idling? YES NO
 - (Neutral gear rattle while idling is normal)
 - If YES, correct as necessary.
- Switch to Sport mode from Normal mode
 - Are upshifts/downshifts more delayed? YES NO
 - Are shifts harsher in this mode? YES NO
- **After road test, perform “Erase and Read All DTCs.”**
 - Is MIL illuminated or any DTCs in any ECU? YES NO
 - If YES, correct as necessary.

PARTS INFORMATION

Use Genuine Mitsubishi parts as listed in ASA CAPS.

Part #	Description	Qty. Req'd
2800A135	Valve Body & Control Unit Assy, M/T Case (Mechatronic Assy) Includes: 1. gaskets (2) – 2800A136 & 2800A137 2. valve body attaching screws (11) – 6 x 55 mm 3. connector attaching screws (3) – 5 x 20 mm 4. new sensor seals (3) – 2800A138	1
2502A042	Cover, M/T Case (Side cover) Includes: 1. cover seal – Not available separately 2. attaching screws (11) – 2502A028 3. connector seal (1) – 2502A038 — NOT USED FOR THIS REPAIR.	1
2513A040	Case Assy, M/T Case Oil Filter (External Filter Assy)	1
C0002610	DiaQueen SSTF-1 Transmission Oil	5.8 qts

WARRANTY INFORMATION

This bulletin is supplied as technical information only and is not an authorization to repair.

A PWA from your DPSM is required for repairs covered by the new vehicle limited warranty. Use labor operation 223810 10.